



Radiant Systems

---

ER0005  APR2022

---

# Heating and cooling radiant ceiling systems

Residential and  
service-industry  
HVAC systems

# Heating and cooling radiant ceiling systems

---

Check **sales terms and conditions** (delivery schedule, freight costs) with our Sales Area Manager.

For the **general sales conditions and warranty** make reference to the general *Catalog Price List Italy* in force or visit [it.giacomini.com/informazioni-legali](http://it.giacomini.com/informazioni-legali).

The information, specifications and prices of products included in this catalog shall not bind Giacomini S.p.A. in any way in case of technical and commercial modifications or printing mistakes.

Copy, also in part, of the catalog contents is forbidden, unless written authorization by Giacomini's Administration is provided.





# Radiant Systems

---

Irradiation is the most natural physic principle for heat and cold transfer, the safest for the environment and the most respectful of human health and comfort. All our radiant systems take inspiration from this principle.

---

**The highest levels of comfort and air quality with  
the best performance in terms of energy saving.  
Radiant ceilings are a winning choice.**

---

Radiant ceiling systems, available as "metal" or "plasterboard" versions, are modern and efficient solutions to heat, cool and furnish the space where people spend most of their time: houses, offices, schools, showrooms, hotels, hospitals, museums is where they find their main application.

Radiant ceiling systems represent **an efficient heating and cooling solution**. They also provide a **high level of comfort** while guaranteeing the best **energy saving rates**. From a mere installation standpoint, radiant ceilings are hydronic systems balancing the sensible loads of air-conditioned spaces to guarantee the appropriate ventilation and keep humidity levels under control when combined to auxiliary systems. The physical phenomenon characterizing heat exchange between the radiant ceiling and the space where it is installed is known as **irradiation**. The picture clearly shows that the radiant ceiling does not create any form of air stratification when heating. The temperature difference between floor-level and ceiling-level air is extremely contained and it is far lower than the one obtained with traditional heating systems. This effect is a key coefficient to reduce air movements - **which in turn further reduce heat dispersion toward the walls** - and increase comfort levels: this is what makes the room temperature ideal tendency and the temperature vertical gradient of radiant ceilings so similar.

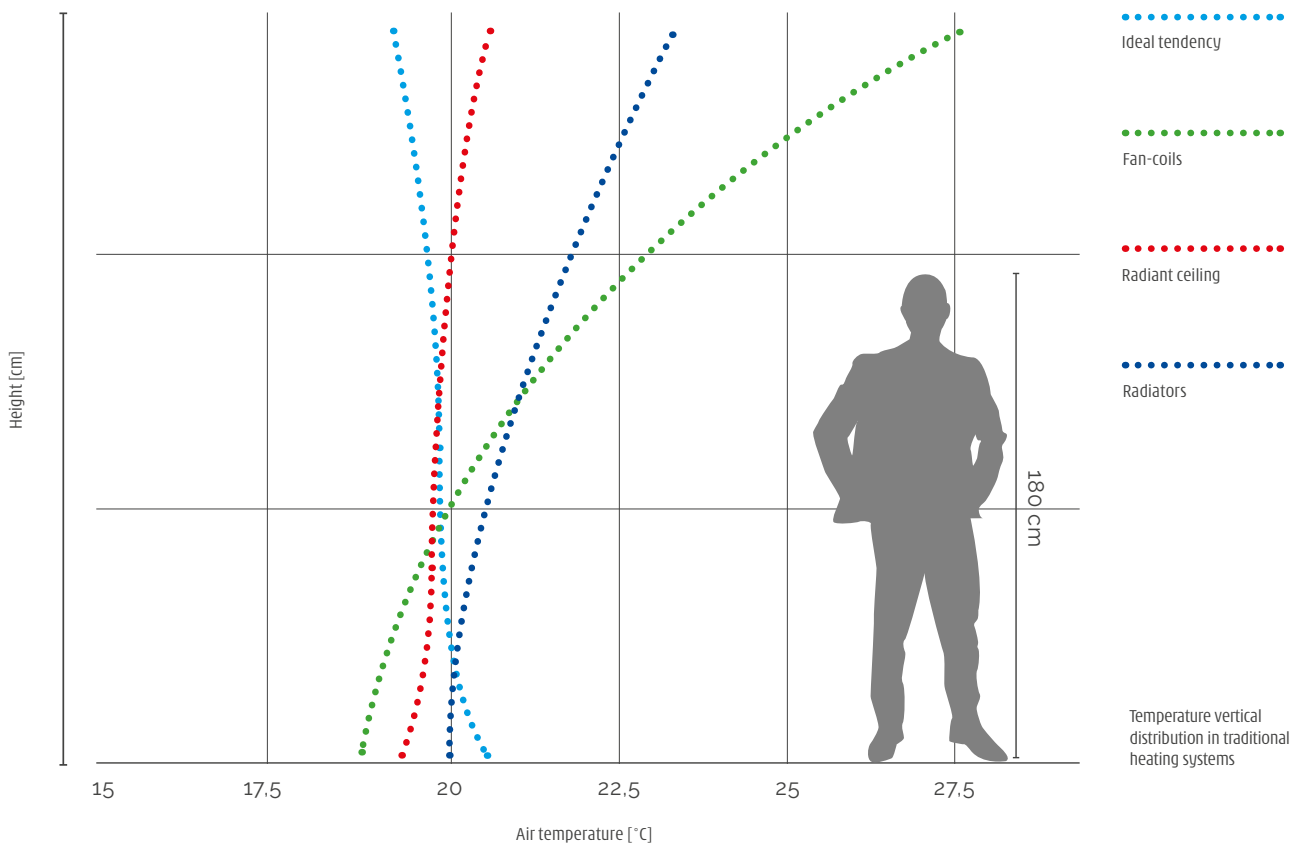



It is a beneficial result which preconceived installers would not have taken into account. The technological evolution of thermoregulation devices has made radiant systems very highly in demand also for **summer cooling** as a winning alternative to traditional fan coils and/or air-only systems, thus becoming reversible systems to be used for the entire thermal cycle of the residential unit. However, while in winter one just needs to increase the room air temperature, in summer both temperature and humidity should be decreased to achieve ideal levels of comfort. This task is appointed to a special **dehumidification system** which reduces humidity by balancing latent thermal loads while the radiant ceiling lowers the temperature by disposing of the sensible thermal loads. Klimabus **thermoregulation** by Giacomini controls at best every parameter of the system to achieve the utmost efficiency at all times.

## BENEFIT

### ➔ **Energy saving**

Radiant ceilings cut down the sensible loads and reduce to the minimum the air required for ventilation based on the estimated crowding and use of the space. Transfer of the same quantity of heat through a radiant ceiling is more efficient compared to air systems as water features a thermal capacity higher than air: a great energy-saving solution that cuts down the costs for the electric power required by traditional fans.

### ➔ **Air quality**

Radiant ceilings can be virtually exploited in a wide range of convenient applications, especially when sensible loads prevail or in rooms where high levels of indoor air quality are required: it is not by chance that they have been widely used in hospitals for more than fifteen years. Paired to ventilation systems for air exchange and humidity control, they ensure the utmost air quality.

**➔ More free space**

Air-only systems obviously require taller vertical spaces compared to radiant ceilings combined to primary air systems; in multi-story buildings, typical of the service-industry sector, the reduction of the "technical volumes" can easily reach the equivalent height of a full additional floor. That is why a radiant ceiling can only offer benefits in terms of free space.

**➔ Noise reduction**

The drastic reduction of the air flow rate of radiant ceilings and the remote position of their ventilation machine sensibly decreases the noise levels typical of air-movement based systems, providing the opportunity to enjoy a quiet and relaxing living experience.







# Types of radiant ceilings

Giacomini's wide range of radiant ceiling systems meets a variety of planning and installation requirements thanks to their field of application.

The entire family of radiant ceiling systems includes two product classes:

- **metal-finish panels**, generally used in hospitals and service-industry buildings
- **plasterboard-finish panels**, particularly indicated for residential buildings.

## Metal Radiant Ceilings

The modern service industry: true architectural freedom, full optimization of the building surfaces and volumes, enhanced healthiness and top-notch indoor comfort. And last, but not least, **tangible energy saving**. The metal panels can be **active** or **inactive**. Active panels provide radiant heat transfer based on their activation system while inactive panels are used only as finish.

RANGE	Model		Modularity - MM x MM	Activation
GK	GK CLASSIC	→ page 12	120 x 60 - 60 x 60	C75
	GK TOP	→ page 18	120 x 120 - 60 x 60	C75
	GK ULTRA	→ page 24	150 x 150	C100
	GK-V ULTRA	→ page 27	135 x 67,5	C100

### Activation C

Heat transfer in C75 activation panels is achieved through a hydraulic circuit made with a 12-mm copper coil combined to four anodized aluminum diffusers. The panel-heat transfer system is preassembled in-house.

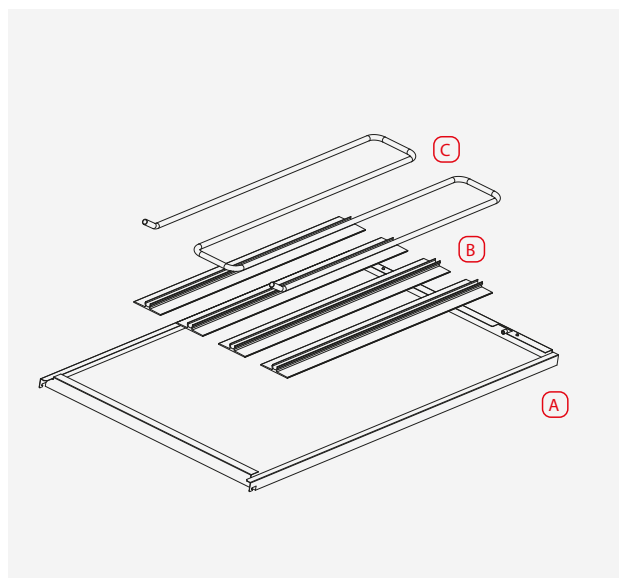

For more details on the types of metal radiant panels  
→ page 12

- (A) Panel
- (B) Heat diffusers
- (C) Copper coil pipe

## Plasterboard Radiant Ceilings

Domestic ceilings can become efficient HVAC systems and an excellent solution also for summer cooling. So perfectly integrated in the architecture to be invisible.. Active panels provide radiant heat transfer based on their activation system while inactive panels are used only as finish. The panels are made by combining a plasterboard sheet to an insulation material which enhances the thermal insulation of the spaces. All panels feature the same thickness. The ceiling zones on the same level require a structure with an equivalent hanging height to obtain a levelled and uninterrupted zone.



For more details on the types of plasterboard radiant panels  
→ page 28

### Activation C

The heat transfer system in GKC panels consists of a 8x1 copper coil integrated in the panel (two with larger panels). The 3-cm thick insulation layer is made of EPS.

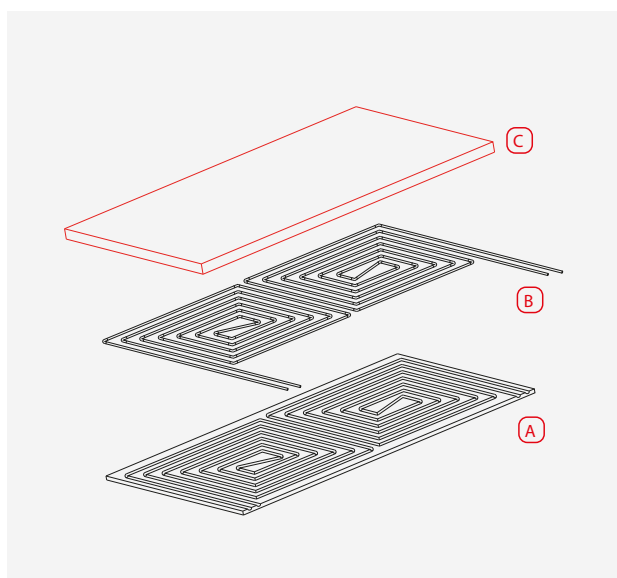

- A** Plasterboard panel
- B** Plastic pipe
- C** Insulation panel

## GK CLASSIC

### METAL

GK CLASSIC is a metal radiant ceiling system fit for heating and cooling of medium-sized service-industry spaces. It features 1200x600 mm and 600x600 mm modular panels for installation on a surface-mount cross-pattern support structure with 24-mm or 15-mm T-shaped supports. The hanging system is designed to provide state-of-the-art planarity to the ceiling. Its panels can be micro-perforated or smooth. Plasterboard is generally used for side compensation.

*Versions:*

*GK CLASSIC 120x60*

*GK CLASSIC 60x60*





### WHY CHOOSE IT?

- Fit for every type of space
- Various types of support structures available (e.g. T24 or T15)
- Quick installation
- Fully inspectionable with system loaded and ON
- Activation system with copper pipe
- Customizable on request

*Find out more at [giacomini.com](http://giacomini.com)*

## GK CLASSIC 120x60



- 575x1175 mm galvanized steel panel, thickness 6/10
- R2516 micro-perforated or smooth panel  
*Other perforations available on request*
- Laying on exposed lightweight reversed T-shaped support structure, surface-mounting, with 15-mm base supports, *(others on request)*
- Steel wire opening and suspension system
- Quick installation: no nuts and bolts required to fit the elements
- Activation with aluminum diffusers and copper coil C75 or plastic coil - A220
- Basic colors: RAL9003, white or RAL9006, silver.  
*Other colors available on request*
- Suspended ceiling module 600x1200 mm
- Fit for spaces of medium and large dimensions
- Optional thermoacoustic mat  
to enhance the system performance
- The use of standardized components provides additional benefits: market availability and convenient installation of the appliances  
accessories: lighting elements, air diffusers and any other additional item for the ceiling
- Inspectionable system

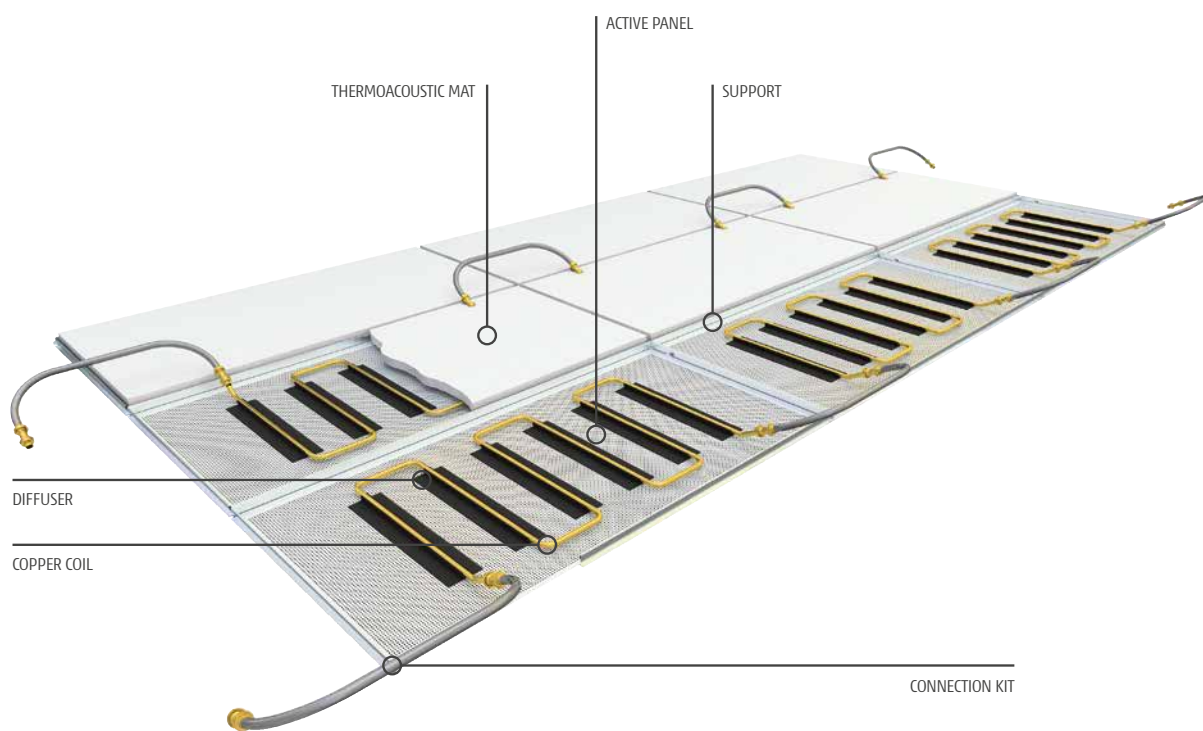

## Types of panels

ACTIVATION **COPPER**

PANEL **INACTIVE**

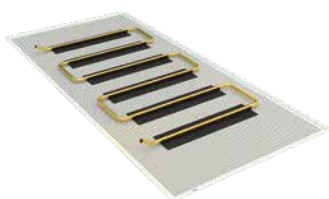

**K12C** - R2516 perforated

**K12** - R2516 perforated or smooth



**K12LC** - smooth

## GK CLASSIC 60x60



- Galvanized steel sheet panel, thickness 6/10, dimensions 575x575 mm
- R2516 perforated panel or smooth  
*Other perforations available on request*
- Laying on surface-mounting lightweight reversed T-shaped structure with 15-mm base supports  
*(others dimensions available on request)*
- Opening and suspension with steel wires
- Quick installation: fitting with no nuts or bolts to connect the elements
- Activation with aluminum diffusers and copper coil
  - C75
- Basic colors: RAL9003, white or RAL9006, silver.  
*Other colors available on request*
- Ceiling module 600x600 mm
- Fit for every type of space thanks to the reduced modularity and limited dimensions of the support structure, it works at best in small rooms or spaces with irregular geometry where it is the system that ensures the best thermal output
- Optional thermoacoustic mat to enhance the system performance
- Thanks to the use of standard-dimension elements, the components are easy to find on the market and its accessories are simple to install: lighting elements, air diffusers and every ceiling accessory
- Inspectionable system



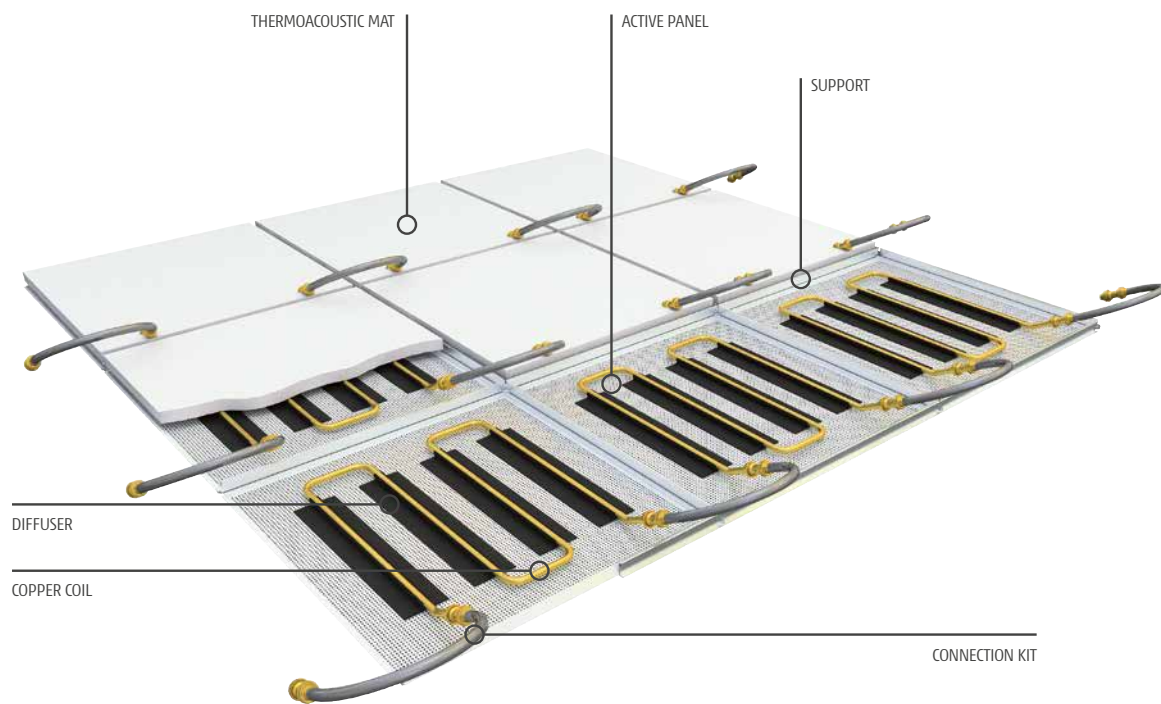

## Types of panels

ACTIVATION <b>COPPER</b>	PANEL <b>INACTIVE</b>
--------------------------	-----------------------

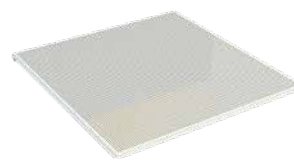

<b>K6C</b> - R2516 perforated	<b>K6</b> - R2516 perforated or smooth
-------------------------------	--

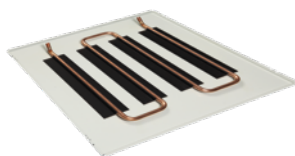

<b>K6LC</b> - smooth
----------------------

## GK TOP

### METAL

GK TOP is a metal radiant ceiling fit for heating and cooling of open spaces such as offices, lounges, commercial spaces, airports, school buildings. It is characterized by 1200x1200 mm modular panels for installation of a 600x600 mm cross-pattern support structure which in turn requires installation of a parallel structure.

The hanging system is designed to provide state of the art planarity to the ceiling.

Its panels can be micro-perforated or smooth.

Plasterboard is generally used for side compensation.

*Versions:*

*GK TOP 120*

*GK TOP 60*



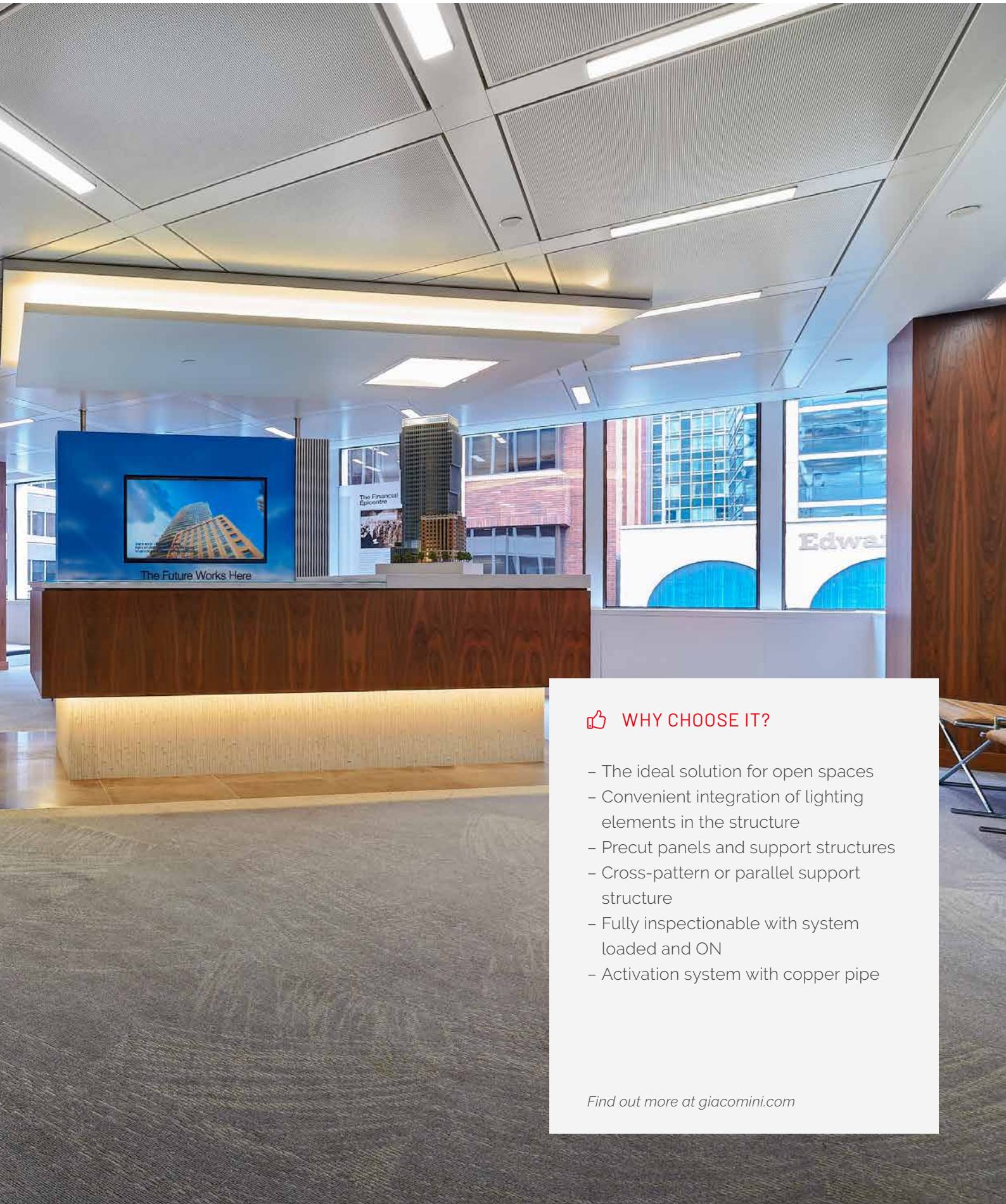

### WHY CHOOSE IT?

- The ideal solution for open spaces
- Convenient integration of lighting elements in the structure
- Precut panels and support structures
- Cross-pattern or parallel support structure
- Fully inspectionable with system loaded and ON
- Activation system with copper pipe

*Find out more at [giacomini.com](http://giacomini.com)*

## GK TOP 120



- Galvanized steel sheet panel, thickness 8/10, dimensions 1030x1030 mm
- R2516 micro-perforated or smooth panel
- Installation on surface-mount cross-pattern support structure with 150 mm base support
- Rotation opening system
- Closing system with fitting springs
- Activation with aluminum diffusers and copper coil
  - C75
- Basic colors: RAL9010, white or RAL9006, silver.  
*Other colors available on request*
- Suspended ceiling module 1200x1200 mm
- The ideal solution for open spaces
- Optional thermoacoustic mat to enhance the system performance
- Convenient integration of lighting elements in the suspended ceiling with precut panels and supports

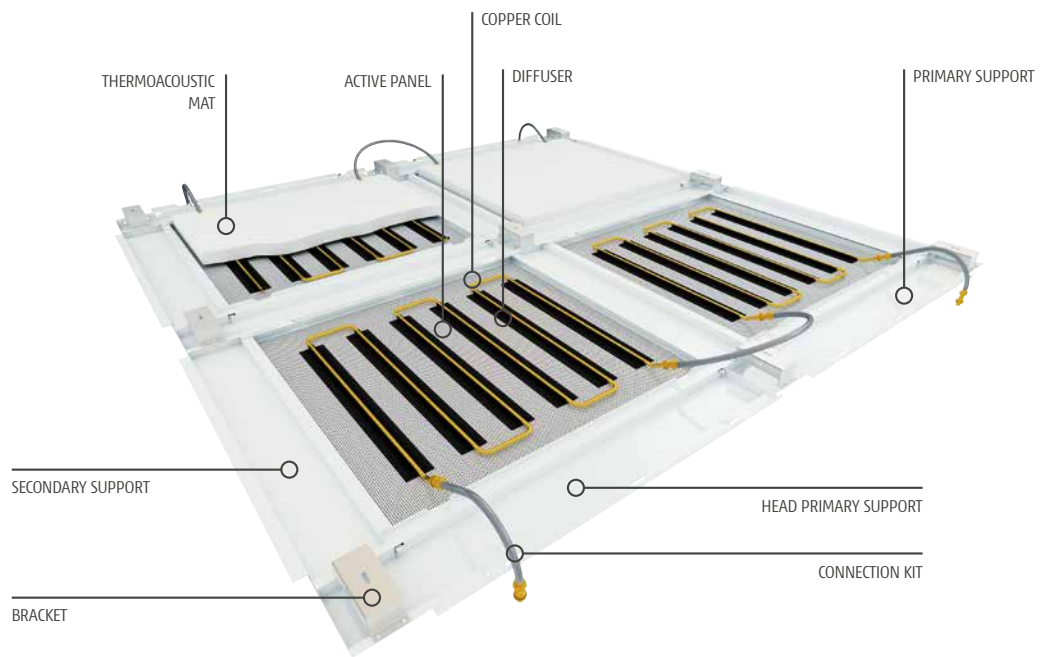

## Types of panels

ACTIVATION **COPPER**

PANEL **INACTIVE**

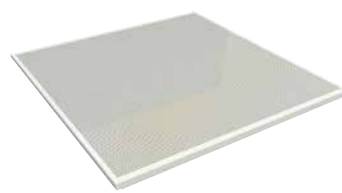
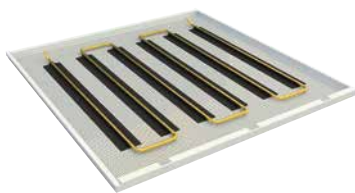

**K120C** - R2516 perforated

**K120** - R2516 perforated or smooth

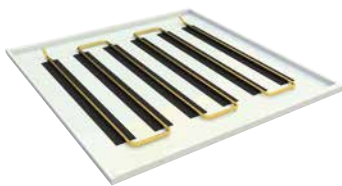

**K120LC** - smooth

## GK TOP 60



- Galvanized steel sheet panel, thickness 8/10, dimensions 596x1030 mm
- R2516 micro-perforated or smooth panel
- Installation on surface-mount parallel-pattern support structure with 150 mm base support
- Rotation opening system
- Closing system with fitting springs
- Activation with aluminum diffusers and copper coil - C75
- Basic colors: RAL9010, white or RAL9006, silver.  
*Other colors available on request*
- Suspended ceiling module 600x1200 mm
- The ideal solution for open spaces or medium/small rooms (meeting rooms, offices, hospital rooms)
- Optional thermoacoustic mat to enhance the system performance
- Convenient integration of lighting elements in the suspended ceiling thanks to precut panels and supports

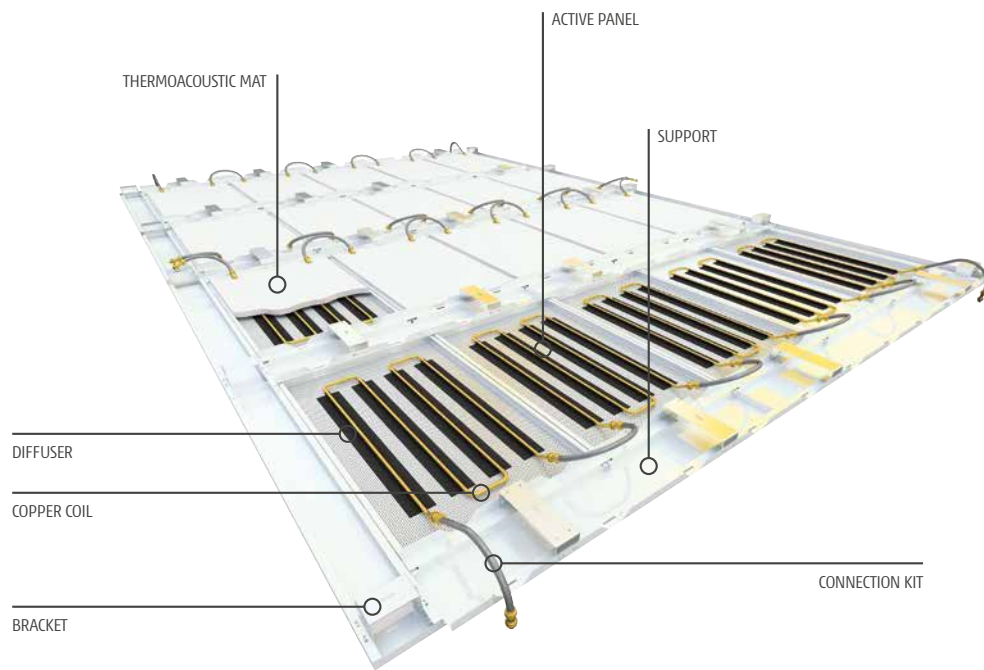

## Types of panels

ACTIVATION **COPPER**

PANEL **INACTIVE**

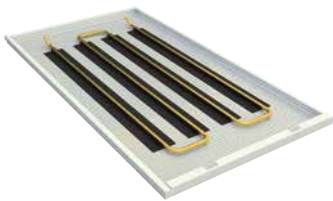

**K60C** - R2516 perforated

**K60** - R2516 perforated or smooth



**K60LC** - smooth

## GK ULTRA

### METAL

GK Ultra is a metal ceiling system especially fit for heating and cooling of open spaces: offices, lounges, commercial spaces, airports, schools. It features 1524x1524 mm modular panels and a cross-pattern support structure. The hanging system is designed to provide state of the state of art planarity and horizontality to the ceiling. Connection of the structure doesn't require screws, bolts or any tool, providing greater safety and shorter laying times. The panels are connected to the structure through hinges and spring-loaded fittings to provide enhanced firmness to the system.

*Versions:*

**GK ULTRA**

**GK-V ULTRA**





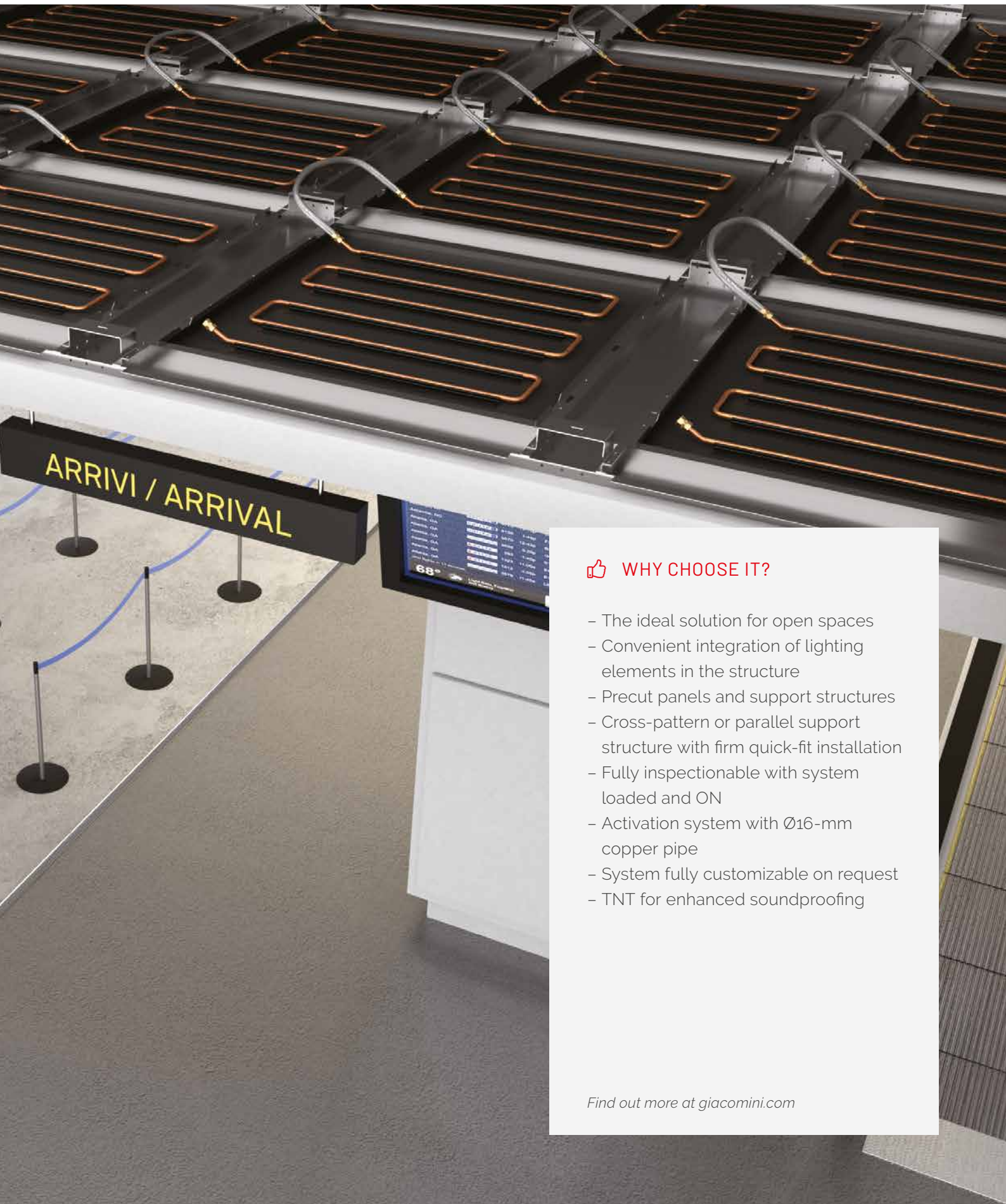

#### 👍 WHY CHOOSE IT?

- The ideal solution for open spaces
- Convenient integration of lighting elements in the structure
- Precut panels and support structures
- Cross-pattern or parallel support structure with firm quick-fit installation
- Fully inspectionable with system loaded and ON
- Activation system with Ø16-mm copper pipe
- System fully customizable on request
- TNT for enhanced soundproofing

Find out more at [giacomini.com](http://giacomini.com)

# GK ULTRA



- Plasterboard is generally used for side compensation.
- Galvanized steel sheet panel, thickness 8/10, dimensions 1350x1350 mm (1525x1524 module)
- R2516 micro-perforated panel
- Installation on surface-mount cross-pattern support structure with 154 mm base supports
- Rotation opening system
- Closing system with hinges and spring-loaded fittings
- Activation with aluminum diffusers and copper coil - C100
- Basic color RAL9010, *other RAL colors available on request*
- Suspended ceiling module 1524x1524 mm
- The ideal solution for open spaces
- Optional thermoacoustic mat to enhance the system performance
- TNT layer on panel upper side for enhanced soundproofing
- Convenient integration of lighting elements in the suspended ceiling with precut panels and supports
- Fully inspectable system

## Types of panels

GK ULTRA - 6/8 ANODIZED ALUMINUM THERMAL DIFFUSERS

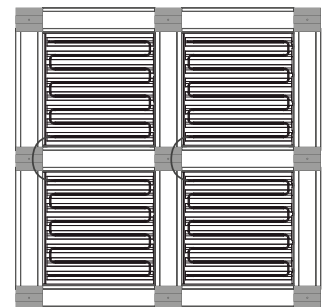

# GK-V ULTRA



- This open-ceiling system does not require side compensation.
- Galvanized steel sheet panel, thickness 8/10, dimensions 1350x1350 mm
- R2516 micro-perforated panel
- Laying on "canopy" support structure fully integrated in the panels
- Quick release
- Activation with aluminum diffusers and copper coil – C100
- Basic color RAL9003, *other RAL colors available on request*
- 1350x675 mm island module
- The ideal solution for open spaces
- 3 types of panels available: right, left and central
- TNT layer on panel upper side for enhanced soundproofing
- Fully inspectable system

## Types of panels

GK-V ULTRA - 4 ANODIZED ALUMINUM THERMAL DIFFUSERS

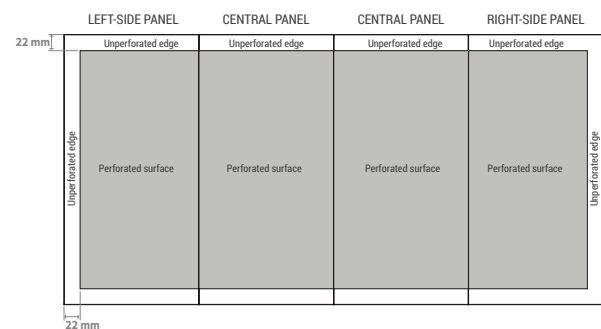

## **GKC CLASSIC, SUPER CLASSIC and ULTRA P**

### PLASTERBOARD

GKC Classic, Super Classic and Ultra P are radiant ceiling systems consisting of preassembled panels with a plasterboard finish. They are fit for heating and cooling of residential buildings and are also widely used in hotel rooms, commercial premises and, more in general, buildings requiring suspended ceilings with a civil-type finish. They consist of a 15-mm thick plasterboard sheet (10 mm for Ultra P) and an additional 30 mm thick EPS insulation layer. Between these two layers is the activation system consisting of one (or two, according to the panel dimensions) 8x1 mm coil. The two models have a different coil pitch: 50 mm for GKC Classic and 30 mm for Super Classic and Ultra P. The versions feature a wide range of applications to meet every need: standard plasterboard, water-repellent, active panels with housing for flush-mounting elements; also available are customizable versions with fire-resistant and soundproofing properties.

*Versions:*

*CLASSIC and SUPER CLASSIC*

*ULTRA P*



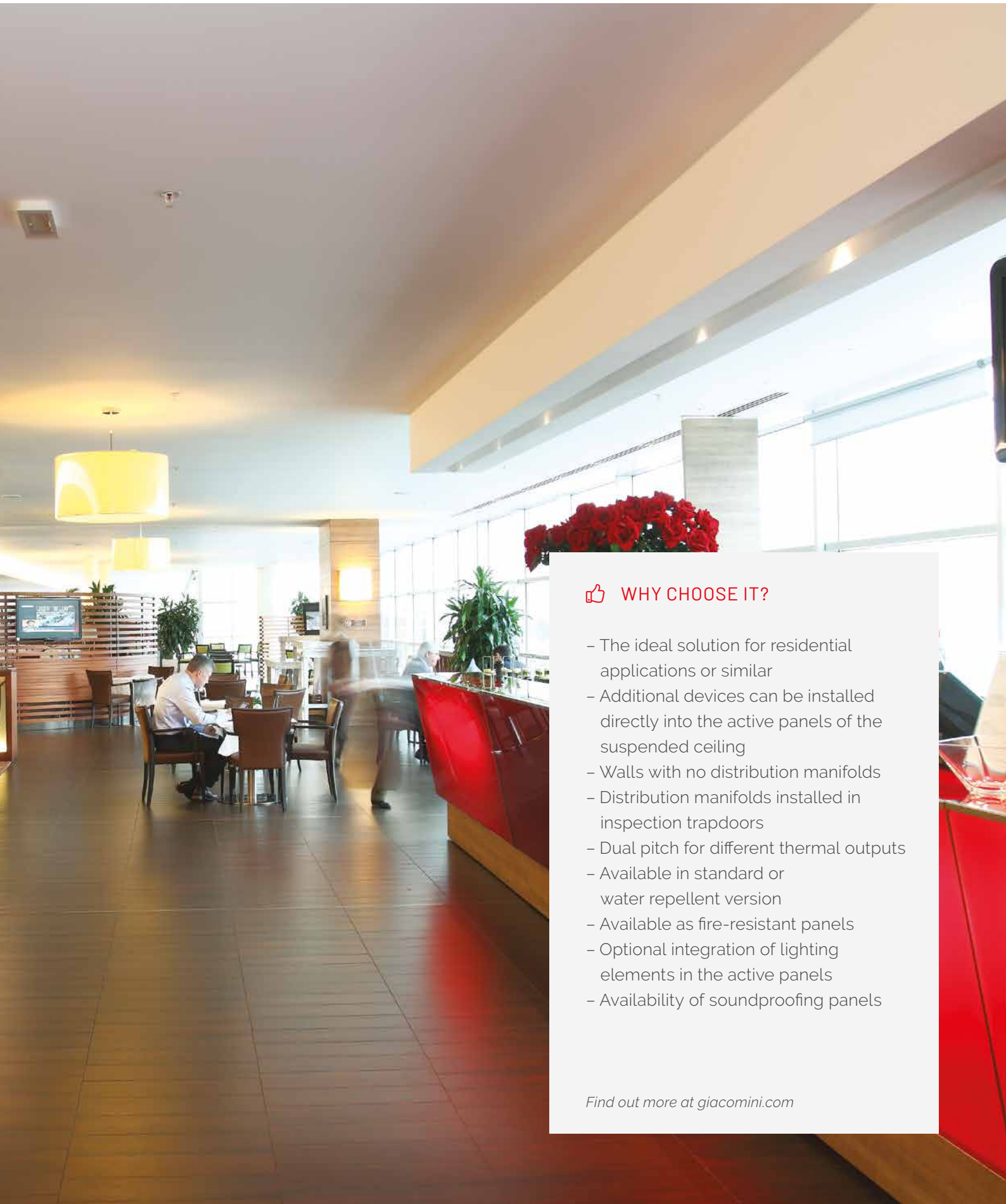

👍 **WHY CHOOSE IT?**

- The ideal solution for residential applications or similar
- Additional devices can be installed directly into the active panels of the suspended ceiling
- Walls with no distribution manifolds
- Distribution manifolds installed in inspection trapdoors
- Dual pitch for different thermal outputs
- Available in standard or water repellent version
- Available as fire-resistant panels
- Optional integration of lighting elements in the active panels
- Availability of soundproofing panels

*Find out more at [giacomini.com](http://giacomini.com)*

## CLASSIC and SUPER CLASSIC



- Four different sizes for modular suspended ceilings:  
600x2000 mm / 1200x2000 mm /  
600x1200 mm / 1200x1000 mm
- 15-mm smooth plasterboard panel with 30-mm EPS insulation panel Overall dimension 45 mm
- Thermal activation integrated in the panel with 8x1 mm coils.  
The 1200x2000 mm panel includes two coils placed in a position that enables to derive two 1200x1000 mm panels with a crosswise cut
- Parallel connection of panels part of the same circuit
- Installation with traditional structures for plasterboard ceilings
- Especially fit for wall-mount installation
- Its modularity makes it fit for every type of space
- Optional installation in the active panels of spotlights and other devices for the suspended ceiling
- Optional water-repellent panels
- Optional soundproofing panels
- Optional fire-resistant panels
- Inspectionable system: the installation of ceiling trapdoors near the distribution manifolds conceals the entire system in the suspended ceiling without encumbering the walls
- Side compensations are made with 30-mm EPS plasterboard inactive panels with insulation. This improves insulation upwards; in addition, installation is easy and quick as all panels feature the same thickness

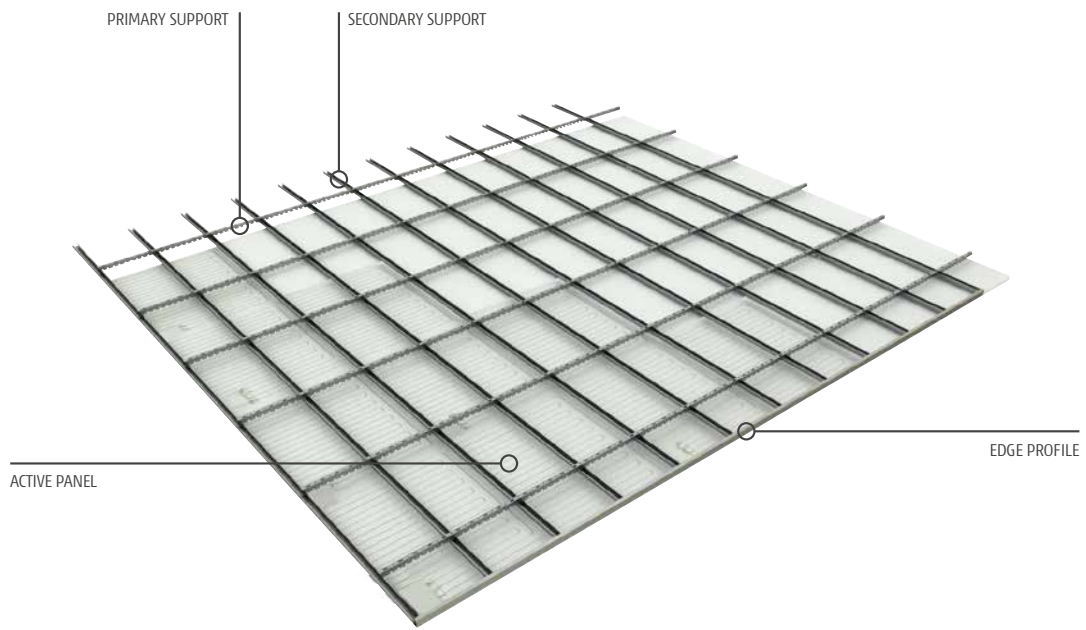

## Types of panels

PANEL		ACCESSORIES	
			
<b>KS120</b> - 1200 x 2000 mm <b>ACTIVE</b>	<b>KS120</b> - 1200 x 2000 mm <b>INACTIVE</b>	<b>KG800</b> - Edge profile	<b>KG804</b> - Support hanger
			
<b>KS60</b> - 600 x 1200 mm <b>ACTIVE</b>	<b>KS60</b> - 600 x 2000 mm <b>ACTIVE</b>	<b>KG800</b> - Primary and secondary support	<b>KG804</b> - Inspection trapdoor

## ULTRA P





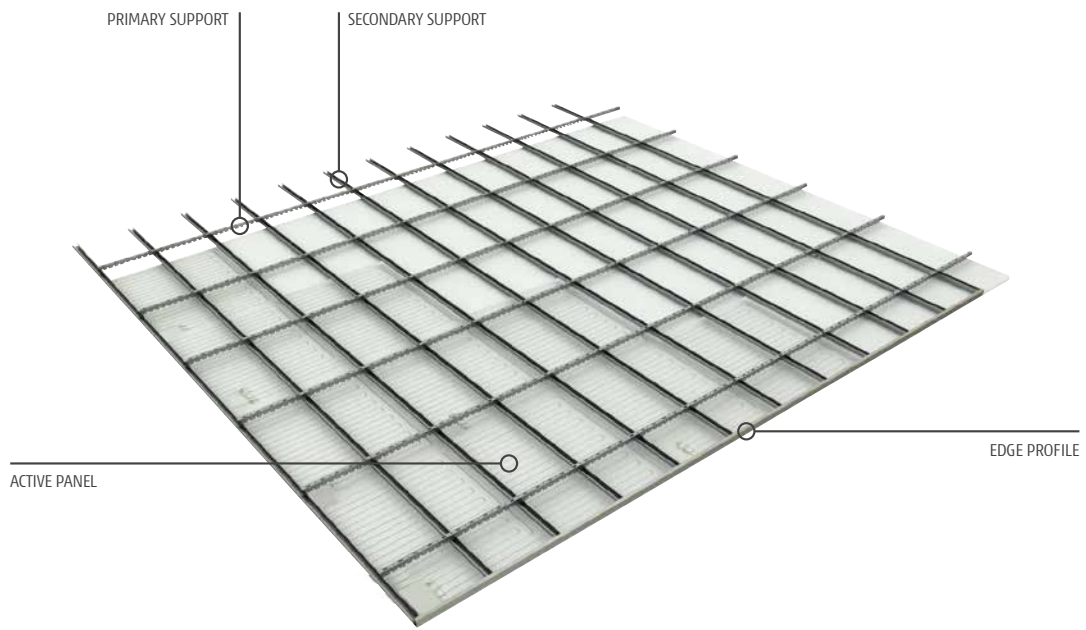

- Four different sizes for modular suspended ceilings:  
600x2000 mm / 1200x2000 mm /  
600x1200 mm / 1200x1000 mm
- 10-mm graphite-enhanced insulation panel  
and 30-mm white EPS insulation.  
Overall dimension 45 mm
- Thermal activation integrated in the panel with  
8x1 mm coils.  
The 1200x2000 mm panel includes two coils  
placed in a position that enables to derive two  
1200x1000 mm panels with a crosswise cut
- Parallel connection of panels part of the same circuit
- Installation with traditional structures for plasterboard  
ceilings
- Its modularity makes it fit for every type of space
- Inspectionable system: the installation of ceiling  
trapdoors near the distribution manifolds conceals  
the entire system in the suspended ceiling without  
encumbering the walls
- Side compensations are made with 30-mm EPS  
plasterboard inactive panels with insulation. This  
improves insulation upwards; in addition, installation  
is easy and quick as all panels feature the same  
thickness





## Types of panels

PANEL		ACCESSORIES	
			
<b>KSUP120</b> - 1200 x 2000 mm <b>ACTIVE</b>	<b>KSU120</b> - 1200 x 2000 mm <b>INACTIVE</b>	<b>KG800</b> - Edge profile	<b>KG804</b> - Support hanger
			
<b>KSUP60</b> - 600 x 1200 mm <b>ACTIVE</b>	<b>KSUP60</b> - 600 x 2000 mm <b>ACTIVE</b>	<b>KG800</b> - Primary and secondary support	<b>KG804</b> - Inspection trapdoor

## Cooling and air treatment

Summer cooling is by now essential in modern HVAC radiant systems, including residential ones. While in winter one just needs to increase the temperature through the heating system, in summer both temperature (cooling) and humidity (dehumidification) need to be reduced to prevent discomfort, ideally by avoiding sudden temperature changes between the inside and the outside and guaranteeing the required protection against condensation. A radiant floor system, combined to units designed specifically for air dehumidification, is a winning option to achieve the ideal thermohygrometric comfort and significant energy saving ratios along the entire annual cycle of occupancy. Giacomini has designed a full range of dehumidification solutions for radiant systems, including high-efficiency machines, for wall flush mounting (KDP) or duct-type suspended ceiling flush mounting (KDS) that provide dehumidification only (isotherm dehumidifiers) or integration of sensible power and primary air treatment (dehumidifiers with sensible cooling integration). KDV represents the top of the range, available with water or air dissipative condenser: in addition to dehumidification and sensible thermal power, it also provides air exchange, with or without heat recovery, and free-cooling, thanks to a high efficiency air-air heat recuperator.

There is a variety of benefits offered by dehumidification units:

- they work on water at 15-18 °C, the same temperature required by cooling radiant systems, and enable cooling units to work at water temperatures higher than the traditional 7 °C of hydronic HVAC systems, with great benefits in terms of energy efficiency (EER - Energy Efficiency Ratio)
- their high latent power/air flow rate ratio - up to 2,5 W per m<sup>3</sup>/h - cuts down the quantity of air required to cover latent loads, resulting in quietness, no drafts and minimum consumption of electric energy

Giacomini thermoregulation controls the entire cooling system by adjusting on a constant basis the water and air temperature, along with indoor humidity, and activating the dehumidification units when needed.

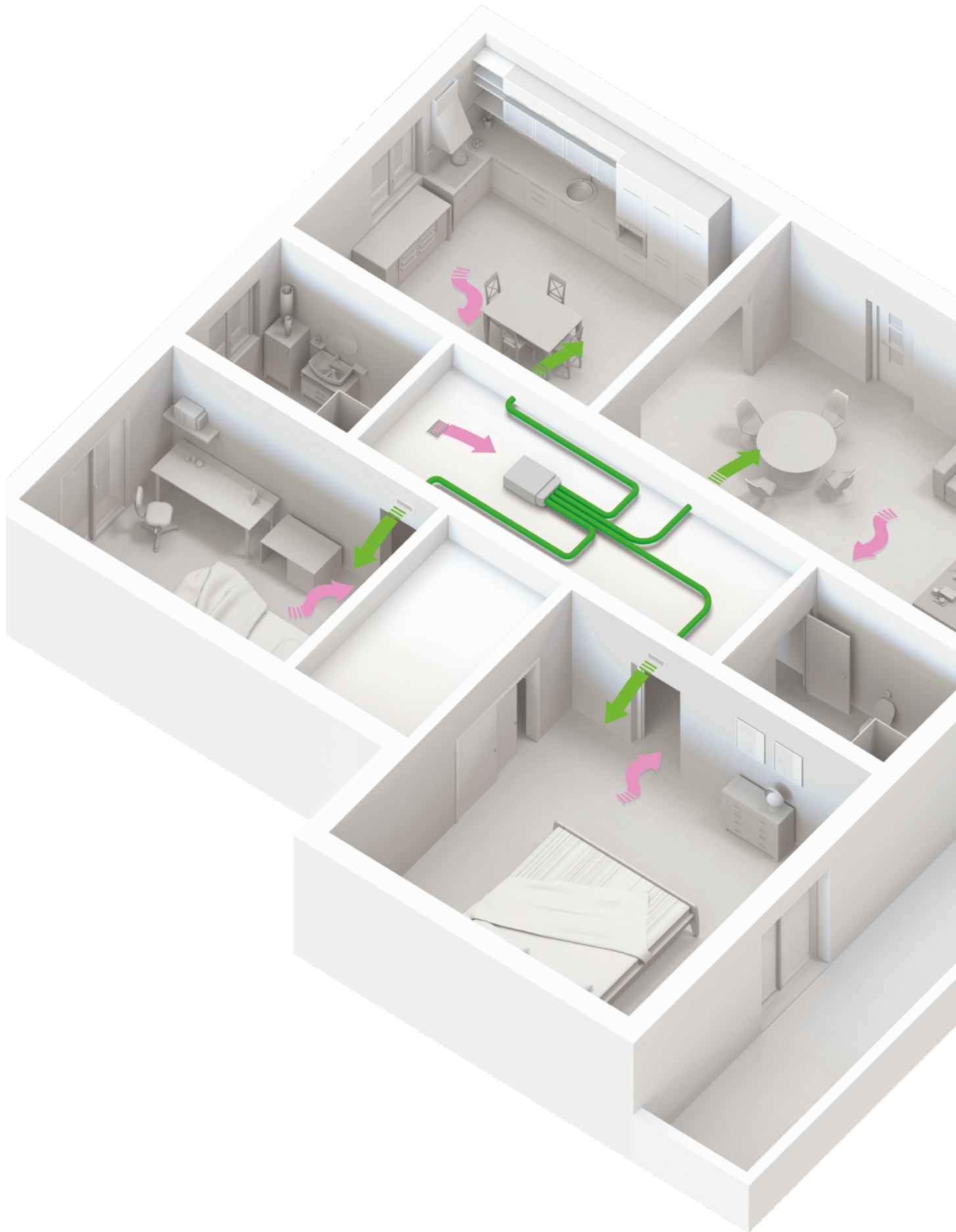

---

# In a nutshell

---



## HRV systems

Heat Recovery Ventilation in Giacomini systems is generally represented by a Centralized Dual-Flow HRV: the ventilation unit, known as heat recuperator, provides air exchange through special ducts in adjoining rooms by extracting exhaust air and introducing fresh air with heat recovery.

Air treatment is also available as optional (dehumidification with or without sensible integration).

As for single-flow systems, this catalog considers exclusively those with decentralized or pinch-point recuperators, with alternated single flow and extraction pinch-point fans (decentralized HRV).



## Hygiene and health

- Continuous and autonomous air exchange
- Control of indoor pollutants
- Reduction of pollutants from the outside (particulates)
- No proliferation of mold caused by humidity contained in air
- Healthy and comfortable indoor climate, guaranteed day and night
- Improved indoor climate for allergic users or individuals with breathing problems



## Safety and comfort

- No drafts and sudden thermal changes
- Noiseless and no insects from the outside, as rooms are ventilated with the windows closed
- Limited risk of burglary for open windows
- Exhaust of indoor smells
- Control of indoor humidity
- Noiseless operation, also during the night
- Ideal indoor climate combined to the radiant system
- Safety against condensation of radiant air conditioning systems
- Adapts to seasonal climatic conditions



## Money-saving and eco-friendly

- Limited heat dispersions
- Thanks to energy recovery, the heating and air conditioning devices may feature smaller dimensions
- Sensible and latent heat recovery of exhaust air enables to limit the heating and cooling system activation
- Efficient use of energy and a resulting reduction of polluting emissions
- Cooling circuits with next-generation cooling fluids to guarantee greater energy efficiency and protect the environment
- Ventilation system repaying itself in time through the energy saving achieved
- Enhanced energy performance of the building
- Increased value of the building
- Tax relief benefits according to the laws in force

## Ventilation units

### KHR

KHR machines are HRV units for freestanding (KHR-V), suspended ceiling (KHR-H) or wall-mount (KHR-Z) installation. They are duct-type machines fit for air exchange in multiple rooms. They basically consists of a high-efficiency dual-flow heat recuperator. The self-supporting monoblock structure includes a single galvanized metal sheet panel combined to a polyethylene pad

(thickness 10 mm) for thermal insulation and soundproofing.

Its radial centrifugal fans feature reverse blades and EC speed modulation motors to enjoy high efficiency, low consumptions and reduced noise. All ventilation units by Giacomini can work in free cooling mode with a motorized damper.



## Dehumidification and integration units

### KDP / KDS

KDP and KDS machines are monoblock units for wall (KDP) or suspended ceiling (KDS) flush-mounting installation. The suspended ceiling version is a duct-type machine, the perfect solution for air treatment in multiple rooms.

Its basic elements include a removable filtering unit, a cooling unit (with pre- and post-treatment coil), a finned exchanger and a centrifugal fan. The machine structure is made with galvanized

metal sheets coated with soundproofing material.

KDP wall-mounting machines include a metal counter-case and a front white lacquered wood panel. Along with dehumidification, specific models offer sensible power integration for the air conditioned rooms: in this case, the temperature of the ejection air is cooler than the inflow air.



# Dehumidification and heat recovery ventilation units

## KHR

KHRD and KHRW machines are dehumidification, integration and primary air treatment units with a high-efficiency air-air heat recuperator. They also include a removable filtering section, two centrifugal fans, five motorized dampers (for delivery, recirculation, extraction, fresh air intake, ejection), cooling circuit and exchange coils. Based on the model, they feature hydronic or thermodynamic integration. The inflow air can consist of two flows: the exchange air and the recirculation of room air, with rates varying based on the type of inflow air treatment. The air flow rates can be set through the control panel.

The basic characteristics of the machine are: summer and winter air exchange with high-efficiency heat recovery, summer dehumidification with temperature control of inflow air, operation with water at the same temperature required by the radiant floor - 15-18° C in summer, 35-40° C in winter - foul air extraction, room air recirculation with free-cooling control, inflow air temperature set through the control panel, possibility to set time slots when the machine is off, separation from the outside by closing the dampers.





# Thermoregulation

Giacomini's thermoregulation offers a wide range of devices fit for operation with radiant systems and able to cover every installation need, from basic to more refined and automated ones which are by now highly in demand in modern buildings. It represents a cutting-edge climatization system able to control at best indoor comfort, both for winter and summer HVAC, with relating air exchange and humidity control.

It consists of:

- room control (secondary): the user can set the desired comfort conditions through the thermostats, with optional integrated relative humidity probe
- boiler room control (primary): based on the user's preferences set through the thermostat set-points, the electronic unit – or master controller - controls the mixing units, the generators and the centralized summer/winter commutation along with air treatment and dehumidification (Klimabus and Klimadomotic systems).

The full range of thermostats and control units has two different technological classifications: stand alone and Klimabus/Klimadomotic systems.

## Stand Alone

The Stand Alone range includes thermostats, chronothermostats and chronothermohumidistats able to work as units autonomous from the control units. The interface between primary (boiler room) and secondary regulation (room) regulation, works through a basic free-contact exchange. Its simplicity represents the true value of this thermoregulation technique: a limited number of devices successfully controls a complex system.



## K492T

The new K492T thermostat is a Wi-Fi weekly chronothermohumidistat with back-lit touchscreen. The white unit can be installed on the wall or on a 503 3-module civil box. Based on the version, it can control thermo-electric actuators, dehumidifiers and fan coils.

Powered at 230 V. Programmable for weekly, daily and manual operation, both for heating and cooling, with an integrated sensor that reads the relative humidity. The K-Domo dedicated app is available for remote control.



Compatible with **Alexa** and **Google Home**  
"Giacomini Wi-Fi Thermostat"



## KLIMAbus

The Klimabus system by Giacomini has been designed with cutting-edge technologies for climatic regulation of radiant systems to achieve the highest rates of efficiency and comfort. The devices are connected through special wires used to transfer messages properly encoded. Klimabus features electronic units, blind probes and thermostats with relative humidity probes part of a logic and structured system which controls at best summer and winter operation.

The Klimabus system can be combined to BMS and monitoring systems through Ethernet, Modbus and Konnex extensions.

When cooling, the electronic unit reads the dew points of each zone through the field bus, by communicating with the room thermohumidistats, and adjusts the temperature set-point of the water delivered to the circuits; in this way it achieves the highest output while preventing condensation.



### K492B

Thermostat with temperature and humidity probe



### K493T

Touch thermostat with temperature and humidity probe



### K495L

Thermostat with temperature and humidity probe



### K495B

Blind thermostat with temperature and humidity probe

To achieve the highest energy efficiency, it is not sufficient to control centrally the temperature of the water delivered to the radiant circuits, as this can affect comfort levels or unnecessarily overheat some rooms. Needs vary based on the individual perception of warmth and cold, the use of the rooms and their geographical exposition or the external or internal natural energy ratio. Individual thermoregulation

offers a rational and convenient solution to this problem while providing the most appropriate temperature for each room or zone, and combining at best comfort and energy saving. This is achieved by interfacing the thermostats with thermo-electric actuators that serve the individual circuits of the radiant floor or with motorized zone valves.

# KLIMAdomotic

KLIMAdomotic is an enhanced smart control system for radiant panel or thermoregulation systems with remote-control (wireless) thermostatic valves. It enables to control every element of indoor comfort - from heating to summer HVAC, air exchange and humidity control - through one single user interface. The KD410 connect control unit must be properly set up based on the system installed. The product will have a software version specific for the different types of installations: Connect-Rad for radiant systems and Connect-TRV for thermoregulation systems with thermostatic valves. With KD410 Connect, the user is connected to the system 24/7: easy to set up thanks to the user-friendly graphic interface, it can be controlled remotely with most smartphones through the "Giacomini Connect" dedicated app.

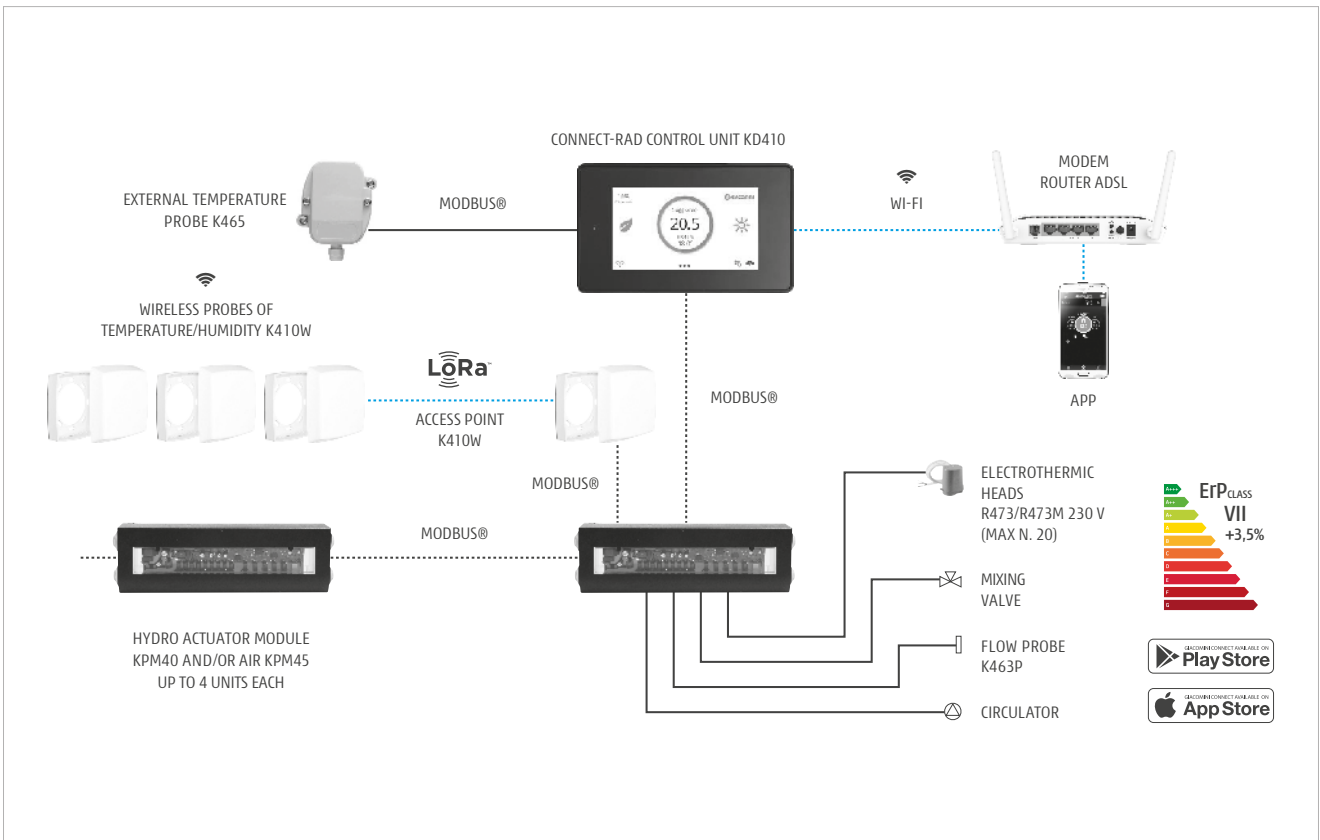
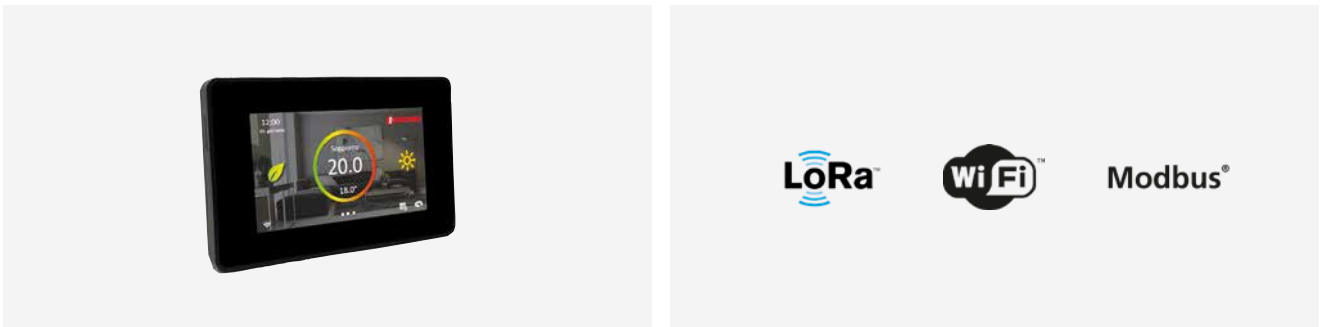

## Benefits of radiant ceiling systems



Ideal comfort



One single system for heating and cooling



High-efficiency and energy saving



The utmost decoration freedom with no aesthetic limits



Noiseless operation and ideal soundproofing

# GIUSO SPA ITALIA



GIUSO





*Giuso spa is the Piedmontese leading firm that produces ingredients and semi-finished products for the confectionery and ice-cream making sector.*

Giuso spa has installed HVAC systems in its seat with GK CLASSIC 60x60 metal radiant ceilings.



# THE EXCHANGE BUILDING CANADA







*The Exchange Building in the center of Vancouver is a 31-story tower certified by LEED Platinum.*

Giacomini provided 30.000 m2 of GK metal ceilings with cross-patter structures and customized dimensions.



# PRIVATE HOUSE

## ITALIA



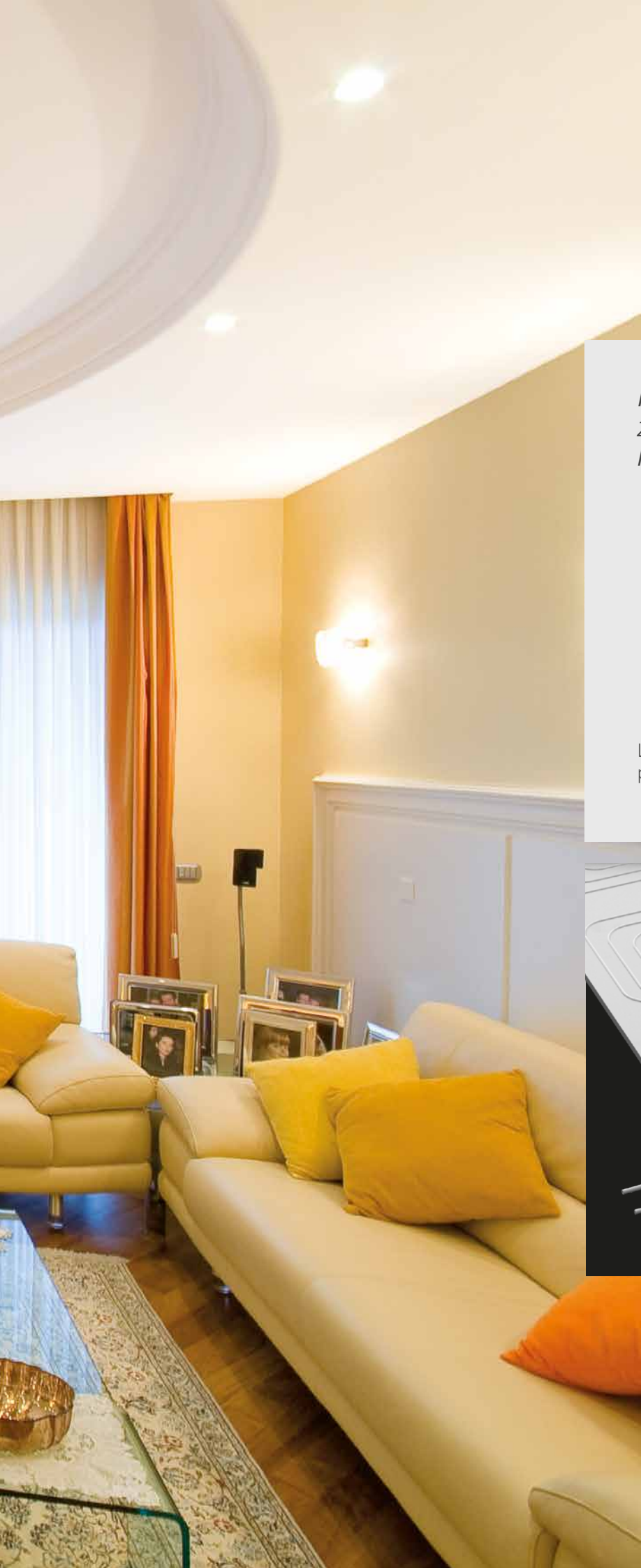

*Refined finish in the living zone of a southern Italy house.*

Lighting elements integrated with the plasterboard ceiling.

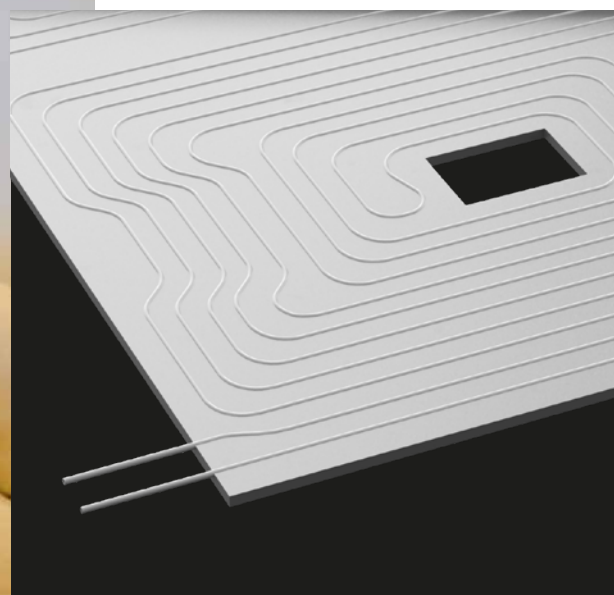

# THE NEW SHERATON MALPENSA - ITALIA



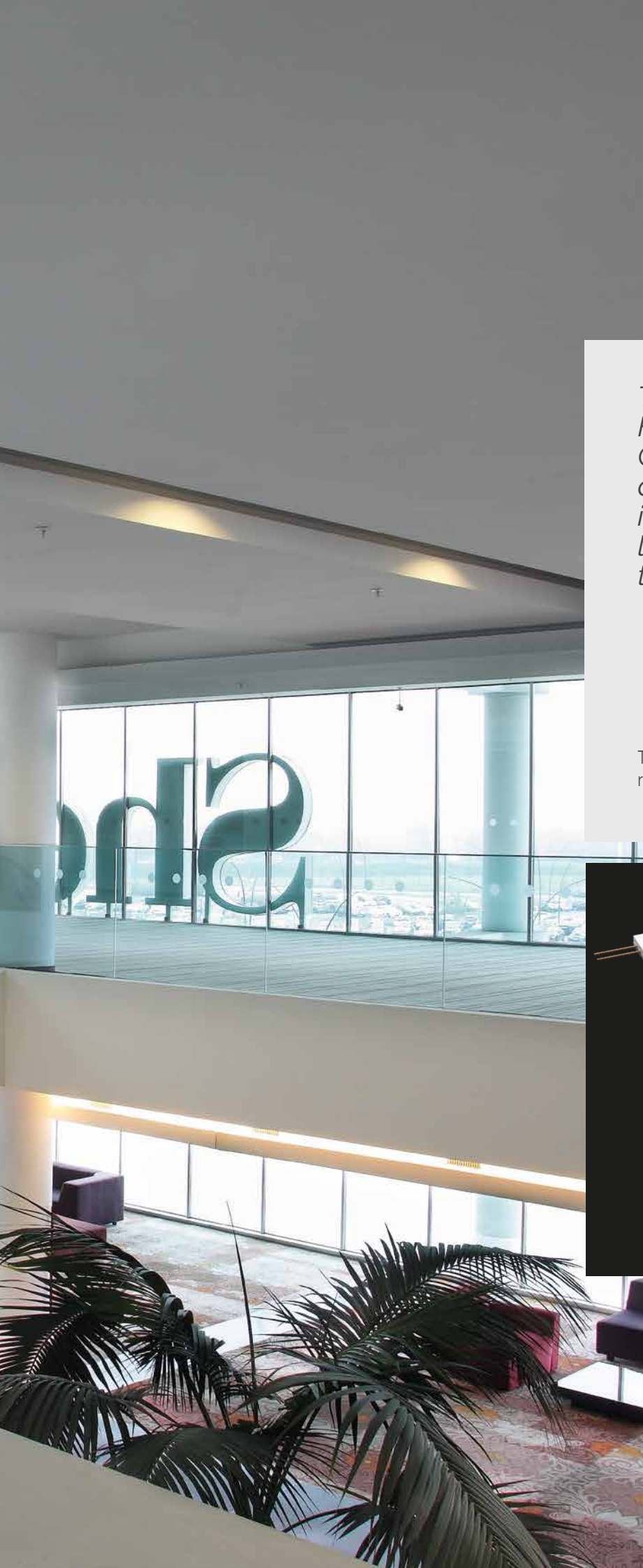

*The Malpensa Airport Hotel & Conference Center has been designed with an international flair for leisure or business travelers.*

The structure features a GKC plasterboard radiant ceiling by Giacomini.

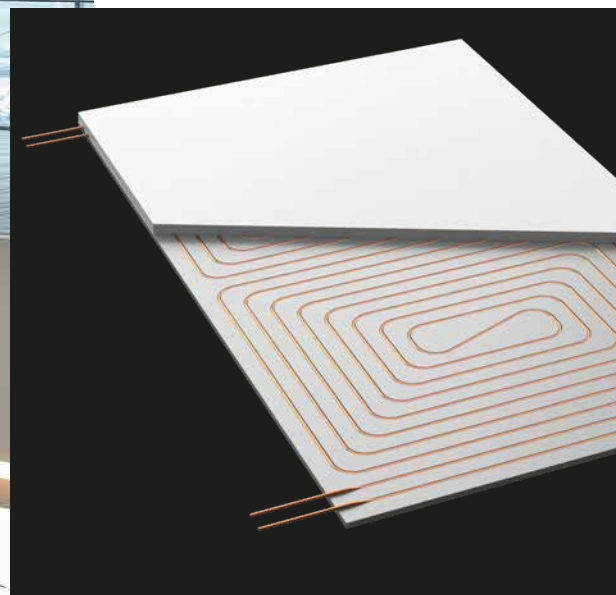







[GIACOMINI.COM](http://GIACOMINI.COM)



**GIACOMINI S.P.A.**  
**VIA PER ALZO, 39**  
**28017 SAN MAURIZIO D'OPAGLIO**  
**NOVARA ITALY**

---

