

**Installation guide Thermal Energy Meter Superstatic 749**

**Installation**

The prescriptions related in the standard EN1434-6 must be respected when the Superstatic 749 is installed.

**Depending on its particular version and use (heat and/or cooling meter), the energy meter must be fitted on the “cold” or “hot” pipe side of the installation in compliance with the indications showed on the LCD display, 1<sup>st</sup> position of the service menu “hot pipe” / “cold pipe”.**

In the standard version, the integrator is parameterised by default for installation on the “cold” pipe side. Installation on the “hot” pipe side must be specified with the order.

In a same installation, mixed mounting positions (horizontal and vertical) can be realized.

Place the flow meter correctly according to the direction of the fluid (an arrow → can be seen on the flow meter).

Horizontal mounting with the integrator facing downwards is not permitted. Also avoid fitting in a position which may cause an air bubble to build up inside the mechanical meter.

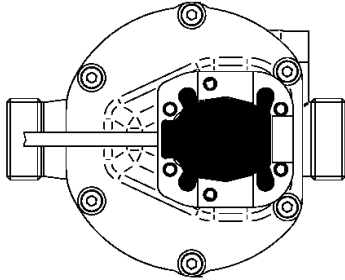

Horizontal Mounting position: The sensor head **MUST** be placed to the side +/- 45° in relation to the pipe axis to avoid influences of air inclusions (top) or dirt (bottom).  
Vertical mounting position: Mounting in riser or down pipes possible.

The energy meter must be fitted between two shutoff valves. The flow meter must be installed ahead of any monitoring valves so as to avoid any potentially interfering influence. Waterproof will be checked at the various mounting points.

**The heat conveying liquid must be equivalent to water without any additives according to standard FW510 of the AGFW (German District Heating Association).** If additives are added to the water, the user must ensure the compatibility of the materials used in the thermal energy meter which are in contact with these additives.

The integrator can be separated from the flow meter and installed at a sufficient distance from the flow meter if:

- The meter has to be installed in a confined space.
- The temperature of the fluid in the flow meter temporarily exceeds 90°C.
- In a cooling installation, possibility to isolate the flow meter.

The pipes are generally free from air before the installation is brought into service. Follow the insulation instructions for cooling installations. Final commissioning must be performed and documented.

**After mounting and before commissioning purge system > 10 min at qp to avoid air bubbles.**

**Wall-mounting of the integrator**

The integrator can be separated from the flow meter and fixed against a wall using the wall fixture supplied with the energy meter. If possible, install the wall fixing component above the flow meter.

The wall fixing component, together with a double-sided adhesive tab, is delivered with the Superstatic 749 (Figure 1).

The wall fixing component can also be screwed on to the wall (screws are not supplied).

To separate the integrator from the flow meter press laterally with one hand on the two locking buttons, while pulling the integrator upwards (Figure 2).

Fix the integrator onto the wall fixing component taking care not to jam the cable which connects the integrator to the flow meter and stick the adhesive tab behind the wall component. Secure the assembly to the wall (Figure 3).

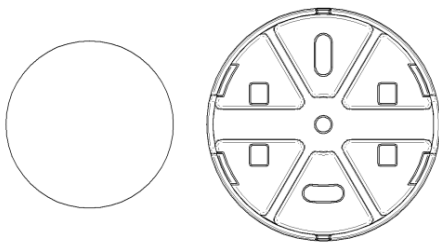

Figure 1



Figure 2

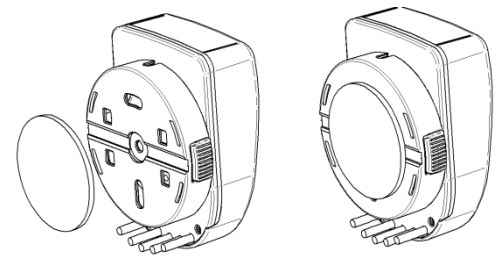
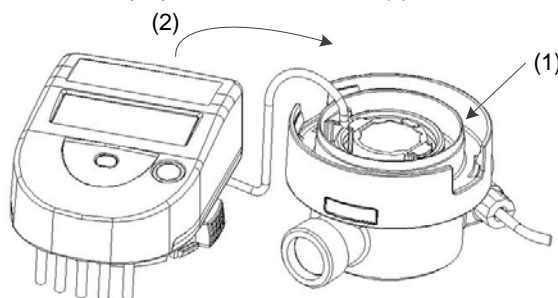

Figure 3

To remove the integrator from the wall support, it will be sufficient to press laterally on the two locking buttons while pulling the assembly towards you. Rewind the connection cable at the position provided for this purpose on the flow meter (1) and re-insert the integrator (2).



**Mounting the temperature sensors**

The temperature sensor cables are provided with a coloured indicator plate:

- Red for mounting in the pipe on the "hot" side.
- Blue for mounting in the pipe on the "cold" side.

The Superstatic 749 is delivered with a cable length of 1.5 m for the temperature sensors.

The temperature sensors form a sub-assembly matching the integrator. The temperature sensor cables must be neither shortened nor lengthened. The temperatures of use shown on the label must be respected.

A temperature sensor may be fitted directly in the Superstatic 749 flow meter. The temperature sensors will preferably be fitted directly, in other words one temperature sensor will be fitted in the flow meter while the other sensor will be installed on the other side of the heat exchanging circuit.

When sensor pockets are employed, these must be used specifically for the two temperature sensors and must correspond to the list set out below.

Asymmetrical mounting is also possible. In that case, a temperature sensor will be fitted directly in the flow meter of the energy meter while the other temperature sensor will be fitted on the other side of the heat exchanging circuit in a sensor pocket defined according to the table set out below. To guarantee accuracy in this type of use, the following conditions must be respected: minimum temperature  $\Delta T_{min} \geq 6$  K when the minimum flow is less than  $\leq 100$  l/h. Make sure that the sensors are mounted until they stall with the bottom of the sensor pocket.

**Sensor pockets list**

Temperature sensors	Versions	Pocket	Article number	Material	Temperature range
Ø 5x31 mm	Pt1000	M10x1	0460A212	Brass	0...100 °C
Ø 5x 31 mm	Pt1000	G3/8"	0460A213	Brass	0...100 °C
Ø 5x 31 mm	Pt1000	G1/2"	0460A214	Brass	0...100 °C
Ø 5.2x 31 mm	Pt1000	M10x1	0460A215	Brass	0...100 °C
Ø 5.2x 31 mm	Pt1000	G3/8"	0460A216	Brass	0...100 °C

**Direct mounting of temperature sensors in ball valves, Ts, Fittings**

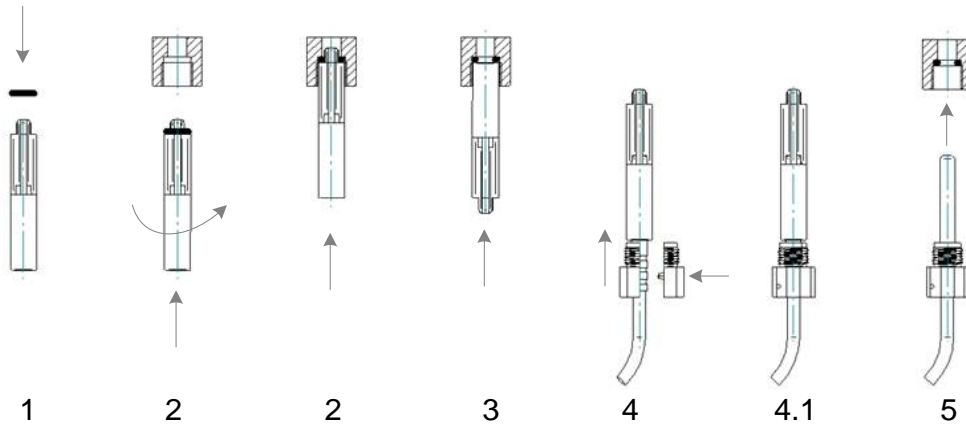

1. Fit the O-ring on the mounting template pin.
2. Insert the O-ring by rotating it using the fitting template in the position provided for the ball valve.
3. Position the O-ring definitively with the other flat end of the fitting template.
4. Insert the temperature sensor in the fitting template and position the two plastic half-nuts in the three grooves of the temperature sensor.
- 4.1 Hold the two half-nuts tightened firmly against each other and remove the fitting template.
5. Insert the temperature sensor with the two half-nuts in the thread M10x1 of the ball valve and screw down by hand as far as it will go (tightening torque 3-5 Nm).

**Direct mounting in a T tube**

The temperature sensor is on the same level and perpendicular to the pipe axis (DN15, DN20):

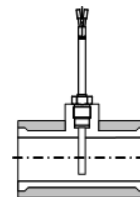

**Fitting temperature sensors for refrigeration applications**

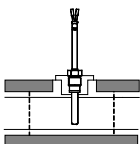

Insulation will only be provided as far as the fixing screw

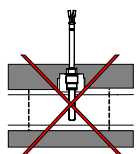

The temperature sensor fixing screw must not be covered by any kind of insulation. This likewise applies if the sensor is fixed directly in the flow meter.

**Mounting of the integrator for a cooling application**

Only the flow meter can be fully isolated. Separate the integrator from the flow meter and fix using the wall support aid

### Commissioning and checking operation

After installing the Superstatic 749 energy meter, the temperature sensors and the flow meter must be sealed and brought into service. The waterproof of the installation must be checked.

Make sure that the measurements indicated by the meter are coherent using the orange button which you will find on the meter. The following values can be shown on the LCD display: flow, power, hot and cold temperatures. The communication arrows permit display of the controls (inputs) and responses of the instrument (outputs). **All the display parameters will be used to check and adjust the installation. In particular, you must make sure that the maximum flow rate of the installation does not exceed the maximum flow rate authorised for the meter. To complete the functional analysis, the commissioning protocol can be saved using the Prog739-749 software via the optical interface.**

### Installation of the Superstatic 749



To install the Superstatic 749, the following steps must be respected :

- Flush out the installation pipes carefully in compliance with the DIN/EN standard specification.
- Close the shutoff valves before and behind the meter.
- Open the drainage valve to reduce the pressure and discharge the water contained in the pipe between the two shutoff valves.
- Consider the direction of flow circulation. Check the flow direction with the arrow figuring on the flow meter.
- Place a gasket on each side of the flow meter. Only use appropriate new gaskets.
- Make sure that the gaskets are carefully positioned in relation to the water pipe and flow meter unions.
- Tighten the fixing nuts firmly by hand. Then tighten up to the mechanical end stop using a mounting tool.
- Install the temperature sensor.
- Turn the display into the desired position for reading.
- Check the waterproof of the meter placed under pressure.
- Seal the flow meter and the temperature sensors.

### General

The compact thermal energy meter **Superstatic 749** is a precision measuring instrument approved for individual metering of heating systems and must be handled with care.

The Superstatic 749 is available in a heating or cooling version and determines the thermal or cold energy exchanged by a heat-bearing fluid in a heat exchanger circuit.

The Superstatic 749 complies with the requirements of the European Directive MID 2004/22/EC modules B and D and of the standard EN 1434 class 2.

### Important!

The energy meter may only be used under the conditions indicated on the manufacturer's rating plate!

In the event of failure to comply with these instructions, the manufacturer declines all liability.

The seals must not be removed or may be removed only by authorised persons.

If these conditions are disregarded, the factory warranty and the calibration will no longer be the manufacturer's responsibility.

The manufacturer will not be liable in the event of any modification of the metrological data or of the measurement parameters if the manufacturer's seal is damaged.

The manufacturer will not be liable in the event of any modification of the metrological data or of the measurement parameters if the manufacturer's seal is damaged.

For cleaning, a moist cloth is sufficient. Do not use solvents.

Do not shorten the cable between the flow meter and the integrator and the cables for the temperature sensors or modify them in any way whatsoever.

### Before installation

Check the installation data and compare them with the specific characteristics of the thermal energy meter.

The rules for installation and those relating to the project must be respected.

The environmental temperature range for the energy meter is 5...55 °C.

Make sure that the meter and the labels can be read easily.

All connections must be made at a minimum distance of 300 mm from high frequency or high voltage cables. Avoid thermal radiation and interfering electrical fields near the integrator and connection cable.

As a rule, the integrator must be installed at a distance from pipes carrying refrigerating fluids.

Action must be taken to ensure that no condensation water can penetrate inside the integrator.

If there is any risk of vibrations, the integrator must be installed separately on the wall.

If the specific temperature of the fluid within the flow meter regularly exceeds 90°C, the integrator must be installed separately from the flow meter.

It is advisable to drain the installation before fitting the flow meter. This will enable any foreign body to be withdrawn from the pipe.

### Security with lithium batteries

3V lithium batteries are used. Batteries must be manipulated with caution:

Do not recharge or short-circuit, protect against humidity, do not expose to heat, do not throw batteries in fire, keep out of reach of children.

Do not replace the batteries with a type other than provided by the manufacturer.

### Advice on disposal:



In order to maintain and protect the environment, to reduce waste of natural resources and prevent pollution, the European Commission has established guidelines according to which manufactures must take back electrical and electronic devices in order to forward them to a regulated disposal or recycling system.

If you dispose of the batteries yourself, enquire about the possibilities of recycling in your region.

**Error codes**

The Superstatic 749 integrator displays an error message with the 3 letters “Err” and a code. If several errors occur at the same time, the different codes are added together.

The error is displayed in the first position of the display menu. It will still be possible to select all the other display menus by pressing the navigation button. If the navigation button is no longer pressed for a period of 3 minutes, the error code will automatically appear again in the first position of a display menu. Display of an error automatically disappears when the error is no longer present.

*Err 1:* Flow higher than 1.2 x qs or defective hydraulic sensor.

*Err 2:* Measured temperature outside the homologated range or temperature sensor defective.

To make sure that the temperature sensors have not been cross during assembly, the temperature difference between the outward and return temperatures can be checked on the display. Depending on the use (thermal or refrigerating), this temperature difference may be either positive or negative.

**Display**

The Superstatic 749 LCD display has been designed to be large enough and perfectly readable by the user.

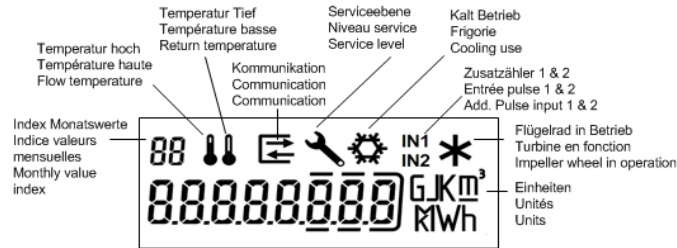

**Display sequence**

To display general data on the integrator, several windows have been created in the form of menu/sub-menu functions. Depending on the chosen version of the energy meter, some menus may be added.

The “Energy” window of the main menu is the basic display.

The navigation button enables the user to change from one menu to another and to access the different positions within a menu.

Short pressure on the navigation button permits transition from one menu to another or continuation to the next display while remaining in the same menu. Long pressure (> 2 seconds) on the navigation button gives access to sub-menu within a menu or enables the “Energy” window to be displayed from within a menu.

After 3 minutes, the display automatically reverts to the basic “Energy” window.

Detailed display sequences:

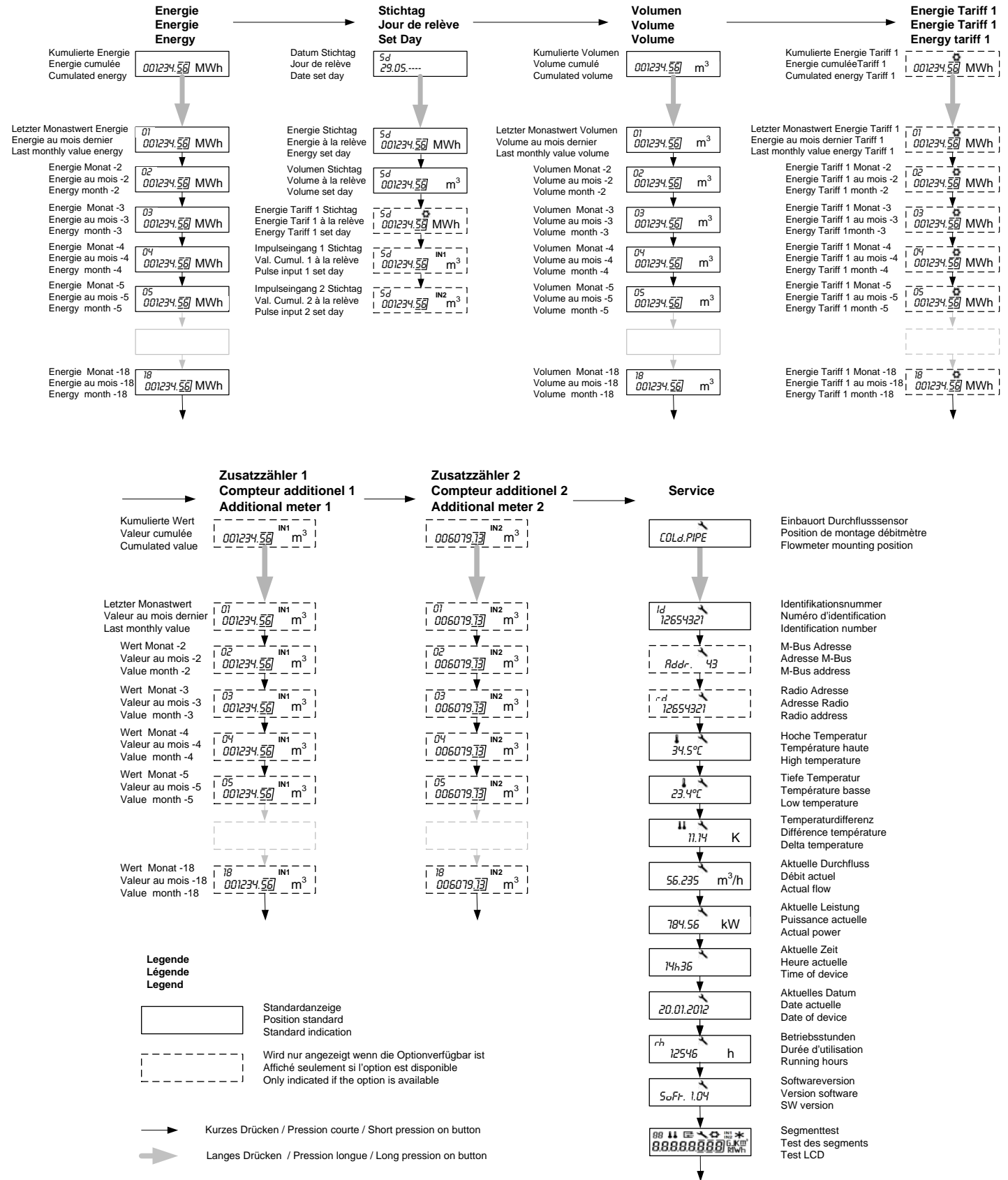

**Communication interface and options**

The communication interfaces are installed and preset in the factory. When ordering, you must specify the interface type: remote powered M-Bus, Radio Supercom or Wireless M-Bus (OMS) and pulse outputs.

**Pulse input function**

Depending on the defined variant, the Superstatic 749 offers the possibility of advantageously integrating up to two further pulse input meters, for instance a hot water meter and a cold water meter.

The value of the pulse factor is programmable via the Prog739-749 software. By default, the pulse factor will be 1 Pulse/Unit for each pulse input.

The meter data are aggregated separately in totalizers and can be shown on the display as IN1 and IN2; they can also be transferred via the communication interface which is installed in the integrator.

The Superstatic 749 is delivered with a cable length of 1.5 m for the pulse meters.

Electrical characteristics of the pulse input meters: power supply 3 V<sub>DC</sub>; R<sub>pull UP</sub> 1 MΩ; pulse factor 0..999.999 m<sup>3</sup>/pulse or without unit.

**Pulse output function**

Depending on the defined variant, Superstatic 749 offers the possibility of integrating two open collector pulse outputs which can represent hot energy, cold energy or volume.

Thermal version:

- Output S1 = Hot energy
- Output S2 = Volume

Thermal/cooling version:

- Output S1 = Hot energy
- Output S2 = Cold energy

Whenever the smallest energy unit (hot or cold) and/or volume displayed on the screen is incremented, 1 pulse will then be transmitted on the corresponding output cable S1/S2.

Example for energy:

- Display 12345678 kWh ==> output pulse value for energy = 1 kWh / pulse
- Display 12345,678 MWh ==> output pulse value for energy = 0.001 MWh / pulse
- Display 123456,78 GJ ==> output pulse value for energy = 0.01 GJ / pulse

Example for volume:

- Display 12345,678 m<sup>3</sup> ==> output pulse value for volume = 0.001 m<sup>3</sup> / pulse
- Display 123456,78 m<sup>3</sup> ==> output pulse value for volume = 0.01 m<sup>3</sup> / pulse

The Superstatic 749 is supplied with a cable length of 1.5 m for pulse outputs.

Electrical characteristics of the pulse outputs: open collector 1 Hz 500 ms.

**Optical interface**

The optical interface is installed by default on each Superstatic 749.

Communication between the Prog739-749 software and Superstatic 749 can be effected with an optical coupler.

The transmission speed via an optical coupler is set at 2400 bauds and cannot be changed.

We recommend the use of optical couplers supplied by: [www.pettechnik.de](http://www.pettechnik.de)

Should communication problems be encountered, please refer to the document User Guide Prog739-749 (integrated as PDF in the software).

Configuration recognised by optical couplers: For the optical probe listed below, we have noted the filters needed to permit correct communication with Pro739-749 software:

Optical probe	Filter
P+E Technik : "K1-98" or "K1-06"	No filter
P+E Technik : "K01-USB"	No filter

**Supercom Radio**

The Supercom Radio communication interface permits communication between all Supercom Sontex radio products. For this communication interface to be available, it must be specified when the order is placed. The radio module will therefore be installed and configured in the factory.

Supercom Sontex units make use of a bi-directional radio technology which is a reliable solution with high performance for a remote metering system (fixed or mobile). The technology employed is based on MFD and Radian 0 protocols and works at a frequency of 433.82 MHz.

The units fitted with the Radio module can be accessed 365/365 days per year from 06:00 to 20:00.

The radio address is displayed in the Service menu if it corresponds to the serial number of the Superstatic 749.

Technical data of the radio communication system:

Bi-directional communication; FSK Modulation; Frequency 433.82 MHz; Radian 0 radio protocol.

**The life cycle is calculated for normal metering. Factors such as: the environmental temperature during use, the number of readings taken etc. influence the battery service life.**

**Powered remote M-Bus**

The powered remote M-Bus communication interface is a serial interface which permits communication between different M-Bus devices via a central M-Bus station (per example: Sontex 634). For this communication interface to be available, it must be specified when the order is placed. The powered remote M-Bus module will therefore be installed and configured in the factory.

The M-Bus protocol is compliant with standard EN1434-3.

By default, the primary address will be configured with the address 0 and the secondary address will correspond to the serial number of the Superstatic 749. To change the value of the secondary address, you must use Prog739-749 software or send M-Bus specific orders. The secondary address corresponds to the identification field ID.

The primary address is displayed in the Service menu with the indication [Addr:].

Technical data for the M-bus communication system:

M-Bus protocol compliant with standard EN 1434-3; free potential interfacing without polarity (the voltage measured on the last device must exceed 36VDC); transmission speed 300/2400 Baud; variable data structure.

Type of cable recommended: telephone cable JYStY N\*2\*0.8 mm<sup>2</sup>

**Security seals**

As sealing varies from country to country, local regulations must be followed. To protect the system against all unauthorised manipulations, the energy meter, the connection screws, the temperature sensors and the sensor pockets must all be sealed. The seals may only be removed by authorised persons. In the event of failure to comply with this instruction, the guarantee obligation will lapse. It is important for the wire seal to be as short as possible so that it is slightly taut. This is the only way of preventing malicious interference.

Position of the seals:

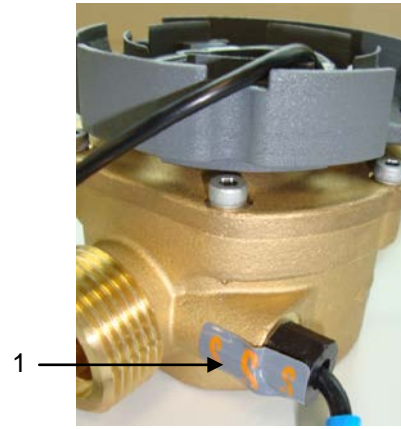
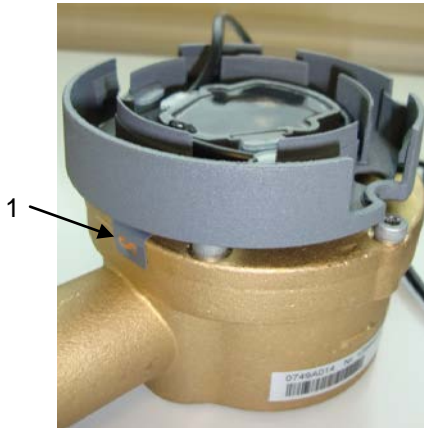

Seals installed in the factory (1) on flow meter and temperature sensor of the Superstatic 749

The detector support fitted on the flow sensor can't be removed without being damaged or broken.

A factory seal (1) will be applied to the temperature sensor mounted in flow meter. To mount the temperature sensor on the other side of the installation,

the Sontex seal  supplied with the meter must be used (S written in black on a grey background).

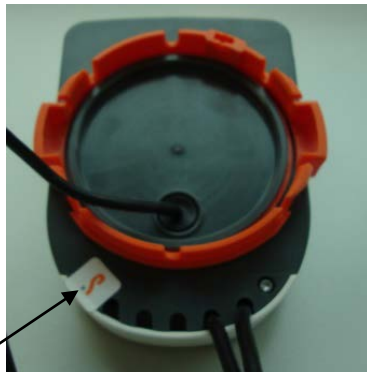

Seal installed in the factory on the integrator

**Technical data Superstatic 749**

**Flow sensor**

qp	Threaded connection		Mounting length	Mat.	PN	Maximal flow qs	Minimal flow qi	Low flow threshold value (50°C)	Threaded hole for sensor	Weight	Kvs value (20°C)	Pressure loss at qp
	G"	DN										
0.6	(EN ISO 228-1) 3/4"	(15)	110	Brass	16	1,2	6	4	Yes	1.2	1.5	0.19
1.5	3/4"	(15)	110	Brass	16	3	15	10	Yes	1.3	3.4	0.2
1.5	1"	(20)	130	Brass	16	3	15	10	Yes	1.4	3.4	0.2
1.5	1"	(20)	190	Brass	16	3	15	10	Yes	1.6	3.4	0.2
*2.5	1"	(20)	130	Brass	16	5	25	-	Yes	-	-	-

\*In pipeline L. Mounting length

The flow sensor Superstatic 749 can be operated from 0,8 bar in the pipe.  
16 bar = 1.6 MPa

Length of straight section fitted upstream/downstream of each flow meter (EN1434):

U3 / D0 for: L=110mm  
U0 / D0 for: L=130mm  
U0 / D0 for: L=190mm

**TECHNICAL DATA SUPERSTATIC 749**

**The integrator**

**Temperature sensors**

Temperature sensor 2 wires	Pt1'000
Diameter	Ø5.0; Ø5.2, Ø6.0 mm
Cables length	1.5 m
Admissible range	0...110°C
Differential range	3...75 K
Response limit	0.5 K
Temperature resolution (display)	0.1 K
Temperature resolution $\Delta t$	0.01 K
Measurement cycle	from 10 seconds

**Environment class**

Environment class	C
Mechanics	M1
Electronics	E1
Battery protection class	III
Cable connection between flow sensor and integrator	0.6 m, fix
Protection index	IP 65

**Permissible temperature**

Operation	5...55°C
Operation: radio version	5...40°C
Storage and transport	-10...60°C

**Power supply**

Lithium battery 3V	6+1 or 12+1 years
--------------------	-------------------

**Pulse output**

Open collector	1 Hz, 500 ms
$V_{CCmax}$ : 50V <sub>DC</sub> ; $I_{CCmax}$ : 0,1 A	

**Pulse inputs with a dry contact**

Power supply <sup>internal</sup>	3 V <sub>DC</sub>
$R_{pull\ UP\ internal}$	2 M $\Omega$
Protection	50 V <sub>DC</sub>
Pulse factor	0...999.999 m <sup>3</sup> /Imp or without unit

**Metrological class**

EN 1434 class 2

**CE conformity according to**

Directive 2004/22/EC (MID)  
R &TTE guideline 1999/5/EC

**Type Examination Certificate**

**CH-MI004-13019**

**Support Technique**

Pour un support technique, contacter l'agent local Sontex ou directement Sontex SA.

**Hotline Sontex:** [sontex@sontex.ch](mailto:sontex@sontex.ch), +41 32 488 30 04

Le certificat détaillé de la conformité est disponible sur le site internet de Sontex SA: [www.sontex.ch](http://www.sontex.ch)